



EWFI1*****

Enjoy peace of mind. Register your appliance today.

Stay updated on better living services,
safety notices and shop for accessories.

- 1. Open the camera app on your smartphone and point at the QR code to scan.**

Product Registration QR code is located on the front of your appliance or inside the door rim.

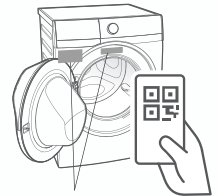

- 2. Tap the notification or link to open the registration form.**
- 3. Complete your details and enjoy peace of mind.**



Full version of the User Manual is available on www.electrolux.com. Alternatively, scan QR code, tap Electrolux logo, and search for your appliance.

Welcome to Electrolux! Thank you for choosing our appliance.



Get usage advice, brochures, troubleshooter, service information, buy accessories & spare parts, online product registration: www.electrolux.com

CUSTOMER CARE AND SERVICE

We recommend the use of original spare parts. When contacting Service, ensure that you have the following data available. The information can be found on the rating plate: Model Name, Product Number Code, and Serial Number.

 Warning / Caution-Safety information.

 General information and tips.

 Environmental information.

Subject to change without notice.

CONTENTS

1. SAFETY INFORMATION	3
2. PRODUCT DESCRIPTION	6
3. TECHNICAL DATA	8
4. INSTALLATION	8
5. CONTROL PANEL AND SMARTSELECT	13
6. DIAL AND BUTTONS	14
7. FIRST TIME START-UP	17
8. BEFORE FIRST USE	18
9. THE AUTODOSE TECHNOLOGY (AUTODOSING)	19
10. PROGRAMMES	26
11.  WI-FI CONNECTIVITY SETUP	31
12. OPTIONS	33
13. SETTINGS	37
14. DAILY USE	39
15. WASHING HINTS AND TIPS	43
16. INTERNATIONAL WASH CODE SYMBOLS	46
17. CARE AND CLEANING	47
18. TROUBLESHOOTING	55
19. ENVIRONMENT CONCERNS	59

2 ENGLISH

1. SAFETY INFORMATION

1.1 Conditions Of Use

This appliance is intended to be used in household and similar applications such as:

- staff kitchen areas in shops, offices and other working environment;
- farm houses;
- by clients in hotels motels, and other residential type environments;
- bed and breakfast type environments;
- areas for communal use in blocks of flats or in laundrettes.

WARNING!

The appliance must not be supplied through an external switching device, such as timer, or connected to a circuit that is regularly switched on and off by utility.

In the interest of your safety and to ensure the correct use, before installing and first using the appliance, read this user manual carefully, including its hints and warnings.

To avoid unnecessary mistakes and accidents, it is important to ensure that all people using the appliance are thoroughly familiar with its operation and safety features.

Save these instructions and make sure that they remain with the appliance if it is moved or sold, so that everyone using it through its life will be properly informed on appliance use and safety.

1.2 Child Safety

- This machine is not intended for use by children or infirm persons without supervision.
- The children should be supervised to ensure that they do not play with the appliance.
- The packaging components (e.g. plastic film, polystyrene) can be dangerous to children-danger of suffocation! Keep them out of children's reach.
- Keep all detergents in a safe place out of children's reach.
- Make sure that children or pets do not climb into the drum.
- This machine is provided with lock option () to prevent children playing with the control panel.

1.3 General Safety

- It is dangerous to alter the specifications or attempt to modify this product in any way.
- During high temperature wash programme the door glass may get hot. Do not touch it!
- Make sure that small pets do not climb into the drum. To avoid this, please check inside the drum before using the appliance.
- Any objects such as coins, safety pins, nails, screws, stones or any other hard, sharp material can cause extensive damage and must not be placed into the machine.
- Wash small items such as socks, laces, washable belts etc. in a washing bag or pillow case as it is possible for such items to slip down between the tub and the inner drum.
- Only use manufacturer's recommended quantities of fabric softener and detergent. Damage to the fabric or appliance can occur if you exceed the recommended amount.
- Do not use your machine to wash articles with whalebones, material without hems or torn material.
- Always unplug the appliance and turn off the water supply after use, clean and maintenance.
- This appliance is not intended for use by persons (including children) with reduced physical, sensory or mental capabilities, or lack of experience and knowledge, unless they have been given supervision or instruction concerning use of the appliance by a person responsible for their safety.
- Under no circumstances should you attempt to repair the machine yourself. Repairs carried out by inexperienced persons may cause injury or serious malfunctioning. Contact your local Service Centre. Always insist on genuine spare parts.
- Pre-treatment sprays and stain remover can damage plastic components on your machine. If you use pre-treatment sprays or stain removers, apply them to the clothing well away from your machine.

1.4 Installation

- This appliance is heavy. Care should be taken when moving it.
- When unpacking the appliance, check that it is not damaged. If in doubt, do not use it and contact the Service Centre.
- All packing and transit bolts must be removed before use. Serious damage can occur to the product and to property if this is not adhered to. See relevant section in section "Unpacking".
- After having installed the appliance, check that it is not standing on the inlet and drain hose and the worktop is not pressing the electrical supply cable.
- If the appliance is installed on a carpeted floor, please adjust the feet in order to allow air to circulate freely.
- Always be sure, that there is no water leakage from hoses and their connections after the installation.
- Any plumbing work required to install this appliance should be carried out by a qualified plumber.
- Any electrical work required to install this appliance should be carried out by a qualified electrician.

1.5 Use

- Only wash fabrics which are designed to be machine washed. Follow the instructions on each garment label.
- Do not overload the appliance. See the relevant section in the user manual.
- Before washing, ensure that all pockets are empty and buttons and zips are fastened. Avoid washing frayed or torn articles and treat stains such as paint, ink, rust, and grass before washing.
- Garments which have been in contact with volatile petroleum products should not be machine washed. If volatile cleaning fluids are used, care should be taken to ensure that the fluid is removed from the garment before placing in the machine.
- Never pull the power supply cable to remove the plug from the socket; always hold the plug itself.

- Never use the machine if the power supply cable, the control panel, the working surface, or when the base is damaged; and where the inside of the machine is accessible.
- If the supply cord is damaged, it must be replaced by the manufacturer, its service agent or similarly qualified persons in order to avoid a hazard.

1.6 Electrical Connection

 "An incorrect power supply may void your warranty."

Check that your domestic electrical installation can take the maximum load required from technical data, also taking into account any other appliances in use.

When the appliance is installed, the power supply cable must be easily accessible.

WARNING!

May cause electric shock! If the machine is not connected to an earthed/ground system. **DO NOT** touch the wet clothes and metal parts. For safety reasons do not use double adapters, extension cords and multi-plug adapters.

CAUTION!

Connect the machine to an earthed socket outlet. The manufacturer declines any responsibility for damage or injury through failure to comply with the above safety precaution. Should the appliance power supply cable need to be replaced, this shall be carried out by our Service Centre.

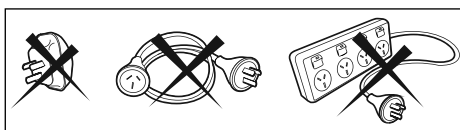

2. PRODUCT DESCRIPTION

2.1 Special features

Your new machine meets all modern requirements for effective treatment of laundry with low water, energy and detergent consumption and proper care of fabric.

- The **interactive touch screen display** makes the setting and the use of the appliance more immediate and agreeable.
- The **AutoDose technology** automatically dispenses the right amount of detergent according to the load; the drawer has two integrated tanks (detergent + softener) and two additional compartments for detergent and additives manual load. It gives the highest use flexibility.

- The **Wi-Fi connection** and **Remote Start** enable you to start a cycle, to interact with your washing machine and to check the washing cycle status in remote control.

2.2 Appliance overview

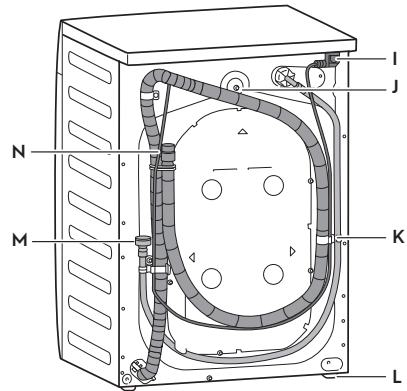
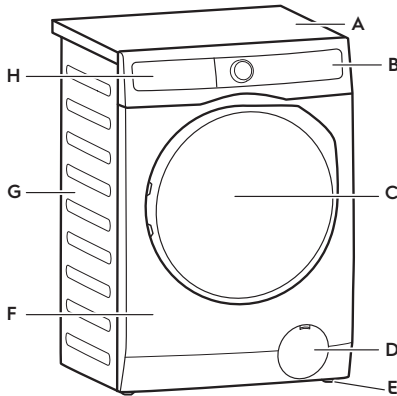

- A** Worktop
- B** Control Panel
- C** Door
- D** Drain Pump Filter
- E** Level Adjustment Feet
- F** Front Panel
- G** Cabinet

- H** Detergent Dispenser
- I** Mains Cable
- J** Transit Bolts
- K** Transit Bolts & Hose Support
- L** Level Adjustment Feet
- M** Water Inlet Hose
- N** Water Drainage Hose

2.2.1 Detergent Dispenser (AutoDose Tanks and Manual Compartments)

For details about using the Detergent dispenser with AutoDose tanks and manual compartments refer to section 9.2

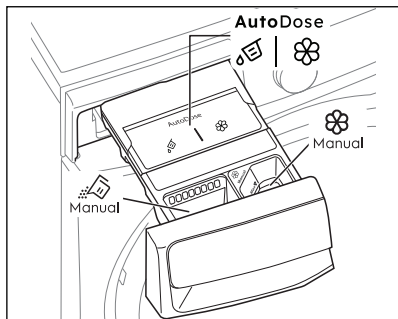

2.2.2 Door (when open)

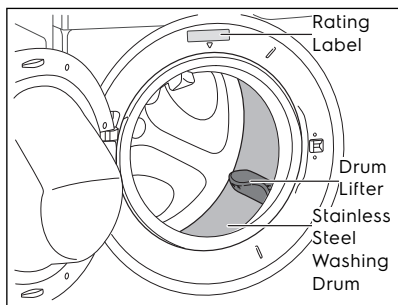

2.2.3 Drain Pump Filter (when open)

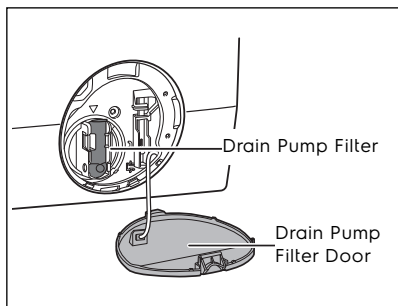

2.2.4 Level Adjustment feet

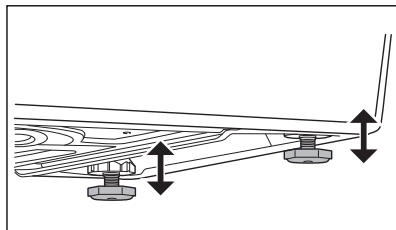

2.2.5 Transit Bolt (when remove)

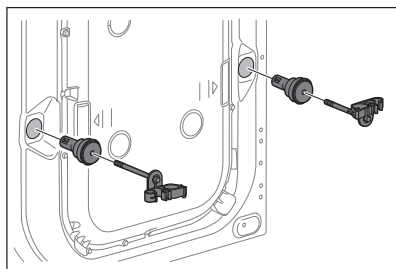
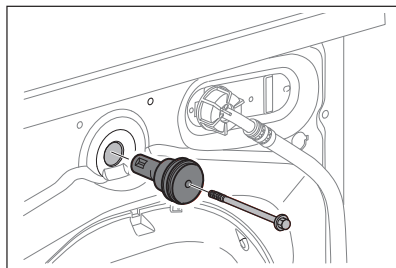

CAUTION!
Transit bolts must be removed before using the appliance

2.3 Accessories

Plastic Caps

To close the holes on the rear side of the cabinet after the removal of the transit bolts.



Plastic Hose Guide

To connect the drain hose on the edge of a sink.



3. TECHNICAL DATA

Dimensions (Height / Width / Depth)	850 x 600 x 659 mm
Power supply (Voltage / Frequency)	220 - 240 V-/ 50 Hz
Total power absorbed	2100 W
Water supply pressure (Maximum / Minimum)	0.8 MPa / 0.05 MPa
Maximum Spin Speed	1400 rpm

4. INSTALLATION

4.1 Unpacking

You are advised to keep all transit devices so that they can be refitted if the machine ever has to be transported again.

⚠ WARNING!

All transit bolts and packing must be removed before using the appliance. Requires using a wrench or hexagon head block number 10 to remove the transit bolts at all 3 points.

⚠ CAUTION!

Carefully put down the appliance with the rear side on it. Make sure not to damage the hoses.

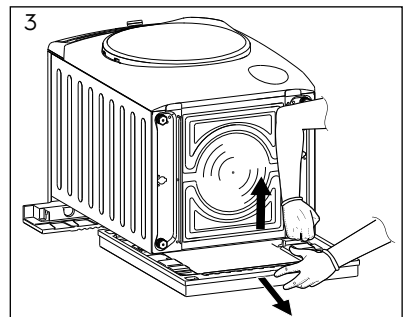
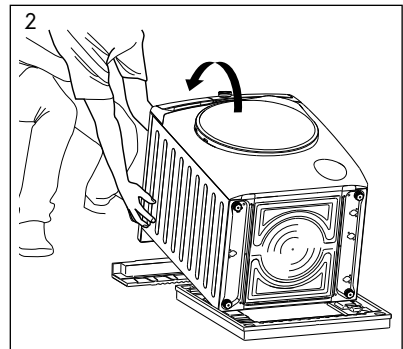
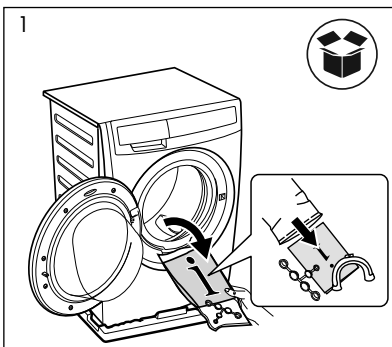

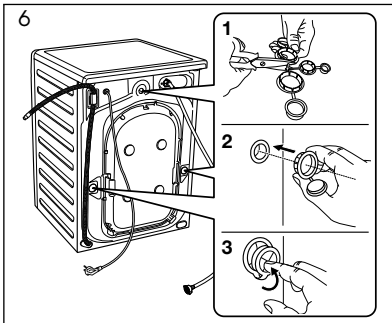
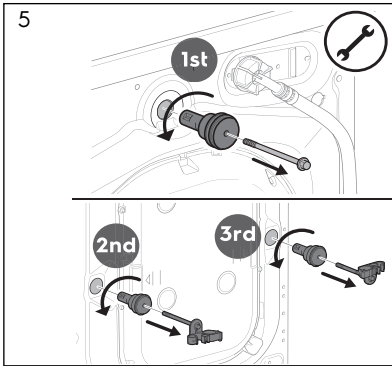
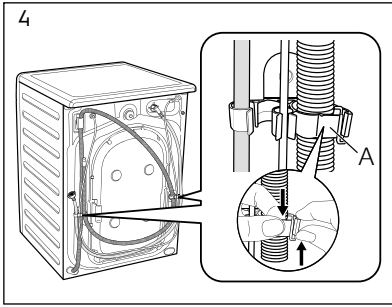

4.2 Positioning

⚠ WARNING!

Before proceeding with installation, read the safety information, and dimension preferred.

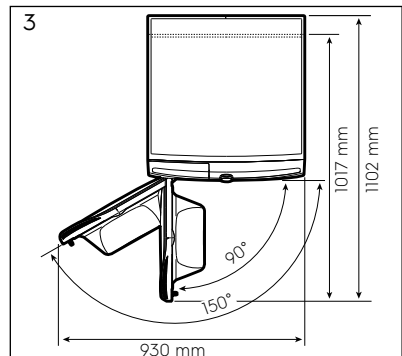
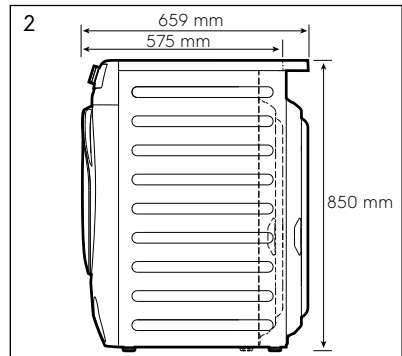
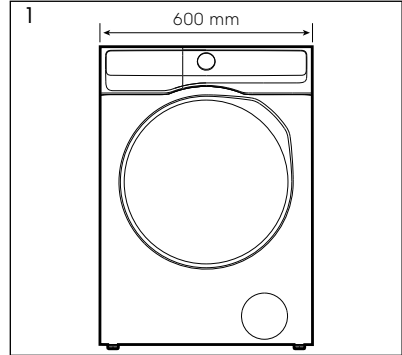

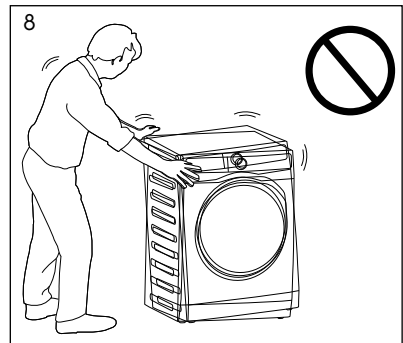
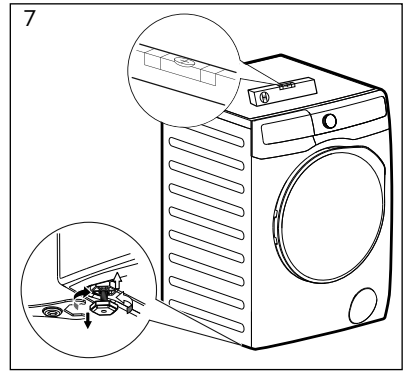
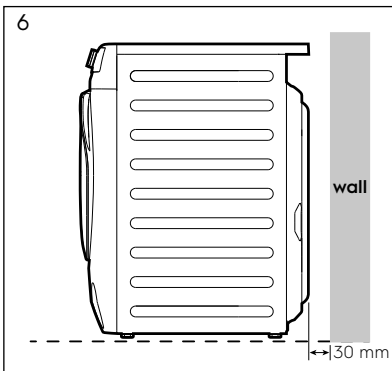
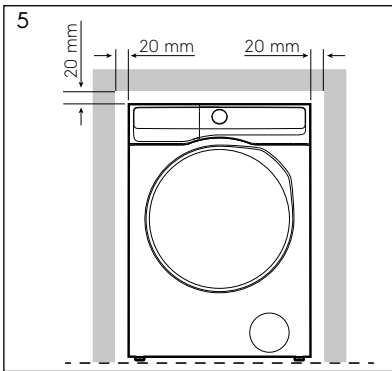
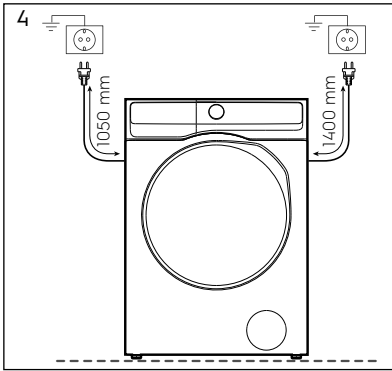

⚠ CAUTION!

When installing the product make sure the levelling feet is not pressing on the power cord.

When the machine is levelled, try to rock it from corner to corner.

If it does rock, adjust the legs again until it is levelled and does not rock.

Never place cardboard, wood, or similar materials under the machine to compensate for any unevenness in the floor. Install the machine on a flat hard floor. Make sure that air circulation around the machine is not impeded by carpets, rugs, etc.

The appliance must not be installed behind a lockable door, a sliding door, or a door with a hinge on the opposite side to that of the machine, in such a way that a full opening of the door is restricted.

4.3 Water Inlet

Connect the water inlet hose to a tap with 3/4" BSP thread. Use the hose supplied with the machine. **DO NOT USE OLD HOSES.**

The inlet hose must not be lengthened. If it is too short and you do not wish to move the tap, you will have to purchase a new, longer hose specially designed for this type of use.

Loosen the ring nut to angle the hose to the left or right depending on the position of your water tap. Do not place the inlet hose downwards.

After positioning the inlet hose, be sure to tighten the ring nut again to prevent leaks.

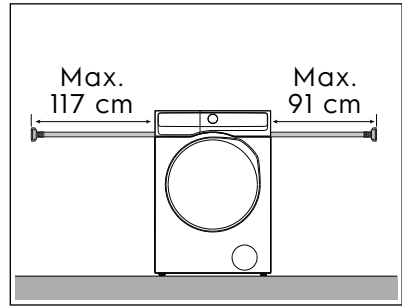
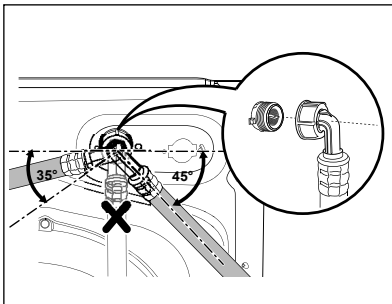
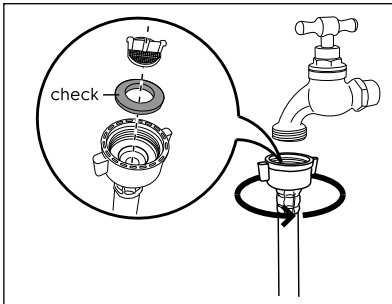

4.4 Water Drainage

The end of the drain hose can be positioned in three ways:

- **Hooked over the edge of a sink**, using the plastic hose guide supplied with the machine.

Fitting Hose Guide

In this case, make sure the end cannot come unhooked when the machine is being emptied. This could be done by tying it to the tap with a piece of string or attaching it to the wall.

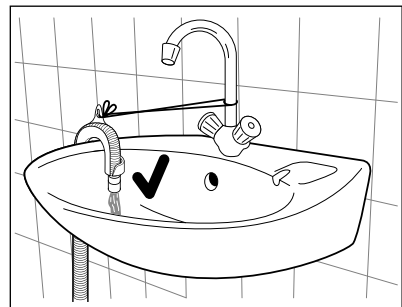
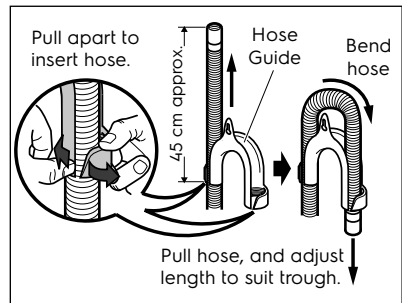

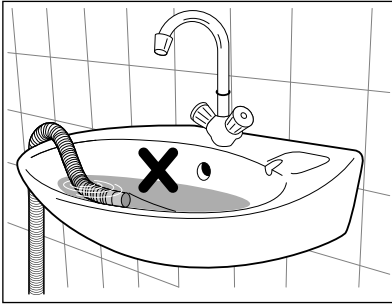

- **In a sink, drain pipe branch.**

This branch must be above the trap so that the bend is at least 60 cm above the ground.

Push the drain hose onto the spigot and secure with a clip, ensure a loop is formed in the drain hose to prevent waste from the sink entering the appliance.

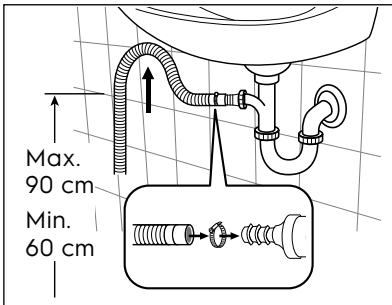

- **Directly into a drain pipe,** at a height of not less than 60 cm and not more than 90 cm.

The end of the drain hose must always be ventilated, i.e. the inside diameter of the drain pipe must be larger than the outside diameter of the drain hose.

The drain hose must not be twisted or curled. Run it along the floor; only the part near the drainage point must be raised.



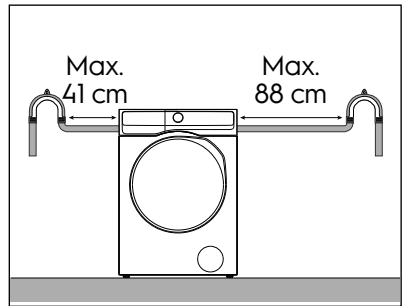
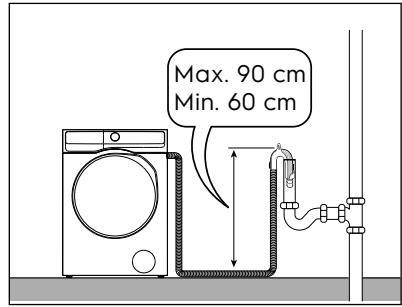





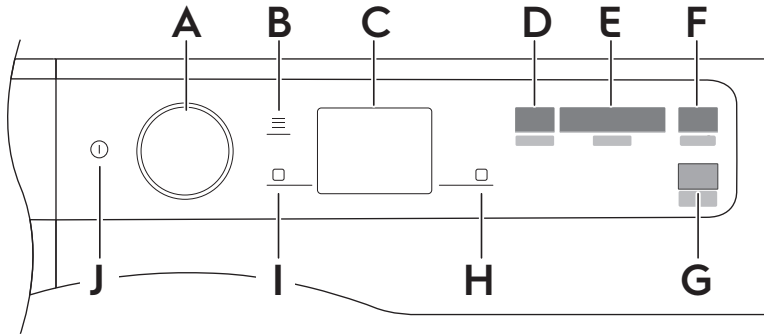

For the correct functioning of the machine, the drain hose must remain hooked on the proper support piece situated on the top part of back side of the appliance.



5. CONTROL PANEL AND SMARTSELECT

5.1 Control Panel Description



- A** Programme selector knob
- B** Menu  touch key
- C** Display
- D** SmartSelect touch key
 - Refresh touch key 
 - Light touch key 
 - Normal touch key 
 - Intensive touch key 
- E** Start/Pause touch key 
(Pause to add Clothes option)
- F** Remote Start touch key 
- G** Right soft key 
- H** Left soft key 
- I** On/Off touch key 

5.2 SmartSelect

SmartSelect is a new and unique feature that allows the user to select the correct washing settings based on the soil level of the fabrics, taking care of the garments and enhancing the user experience.



The washing temperature adapts to each SmartSelect level according to the selected cycle to ensure the best performance, without the need to change the temperature manually.

 For more detail refer to chapter "DIAL AND BUTTON" page 14.















5.3 SmartLeaf feedback

SmartLeaf feedback shows how energy efficient a programme is, based on energy consumption.

There are three different level of SmartLeaf indicated by the leaf icon

1. No leaf lit indicates an average consumption level.
2. One leaf  icon indicates a good consumption level.
3. Two leaf  icon indicates the best consumption level.

5.4 Main symbols legend

Symbol	Description	Symbol	Description
	SmartLeaf feedback icon		Child Lock icon
	Prewash icon		Rinse Hold icon
	App Shortcut icon		Add clothes icon
	Remote Start Mode icon		Door locked icon
	Wi-Fi connection icon		Favourite icon
	Steam icon		Notification icon
	Detergent icon		Softener icon

6. DIAL AND BUTTONS

6.1 On/Off

Press and hold briefly this button for a few seconds to activate or deactivate the appliance. A dedicated jingle sound while switching the appliance on or off, lights and display switches on and Start/Pause button led pulse.

6.2 Programme dial

By rotating the programme dial it is possible to select the desired programme.

Navigate through the programmes

In the display, by turning the dial, several dots representing the available programmes are visible.

- By turning to the right or to the left it is possible to reach the saved programmes or scroll through the entire list.

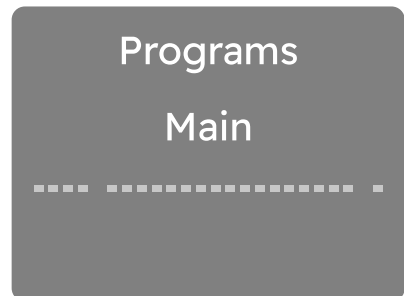

- Turn the dial to the left until the fourth point relating to the last used programme is shown.



- Turn the dial further to the left to view, from point one to three, the Favourites programmes to be saved or already saved.



- Turn the dial to the right to scroll through the entire programme list until the last separate point is reached, which represents access to the additional programme list.

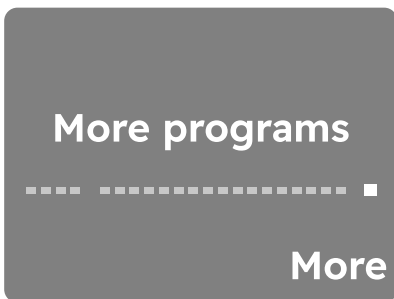

Press the right soft key next to More indication to enter the extra programmes list. Navigating this list works just like navigating the main list.

- To go back to the main list, turn the dial to the left to the Back to main list position and press the left soft key next to Back indication.

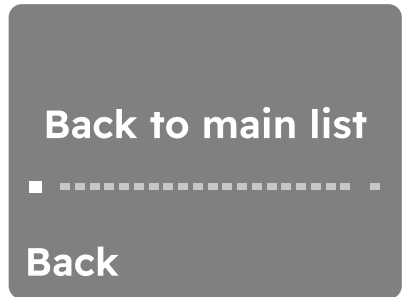

In this view, the last dot represent the reset list position.

6.3 Menu

Tap the  button to enter inside the option Menu.

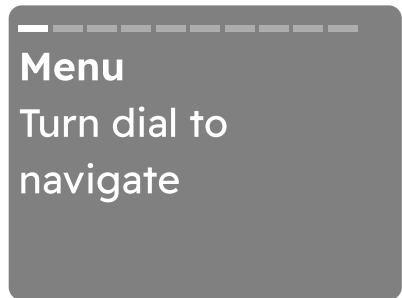



Turn the dial to navigate. To activate/deactivate an option tap the right soft key touch button.

To exit the  user shall:

- press the menu button again;
- press the SmartSelect button;
- press the remote button;
- wait a time out of 10 seconds.

6.4 Right/Left soft key

The two soft keys  buttons are located on the right and the left of the display.

Tap the right soft key  to prompt the action that appears on the right bottom of the display (ex. adjust spin speed, activate or deactivate AutoDose tank, go back in the menu,..).

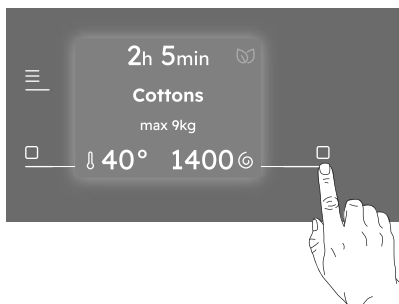

Tap the left soft key  to prompt the action that appears on the left bottom of the display (ex. adjust temperature, activate or deactivate an option,..)

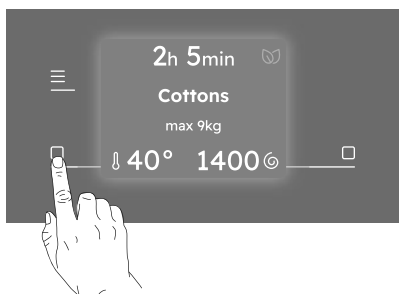

6.5 Start/Pause

Tap the Start/Pause  button to start, pause the appliance or interrupt a running programme.

 A message in the display inform you that the cycle can pause to add or remove garments. Read the "Opening the door - Adding garments" section for more details.

6.6 Remote Start

A quick touch of this  button activates the Remote Start function that allows you to start, pause and stop the appliance remotely.

Activating the Remote start mode the door will lock and the machine goes in a stand-by status.

Press and hold 10 second to reset the Wi-Fi.

6.7 SmartSelect

This new feature has been created to guide the user to save energy, time and water improving the care of fabrics and consumer experience.

For each washing cycle it is possible to have different durations and consumption, based on the level of soiling of the laundry.

 For each programme the appliance suggest a default soil level with a specific temperature. If you change the temperature manually, the soil level could change.

There are four possible options:

1. Refresh

With this SmartSelect level the user selects Vapour Refresh programme. It can reduce wrinkles and light odours and will refresh clothes that does not need a wash.

2. Light

This option is recommended for very lightly soiled clothing, without visible stains. The suggested temperature is cold.

3. Normal

This option is ideal for everyday light soiled clothes, with small stains for example sweat. The suggested temperature is 30°C.

The normal soil level is the one being used most in the default setting.

4. Intensive

This option is recommended for normal/ heavy soiled clothes, with for example food spills or mud.

To activate one of these options turn the dial to select the desired programme. The default soil level icon light on.

To change it tap on the related icon.

 To activate one of this options turn the dial to select the desired programme.
The default soil level icon light on. To change it tap on the related icon. Every SmartSelect level can modify temperature, spin speed and programme duration of the selected cycle.

 If a certain soil level is not available, pressing it will generate an error, a double beep and symbol blinks twice.

7. FIRST TIME START-UP

Each time you turn the appliance on, the Start-up Screen appears on the touch screen.

The first time you turn the appliance on, after the Start-up Screen you are guided through the initial setup procedure.

7.1 Discover your appliance

The first time you turn the appliance on, the display guided through some information related to the appliance.

If user skipped it during first power on, it will show again on the next power up after start up. If user has press skipped for the second time, do not show anymore.

7.2 Language setup

Scroll through the list of languages by rotating the knob to find the desired language and select it by pressing the right soft key.





 By turning the knob the selected language will be visible in bold.

7.3 Water Hardness

The display suggests to set the proper water hardness level to improve the washing results.

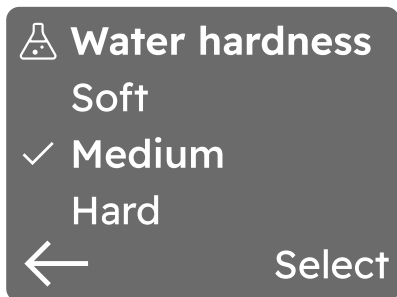
The following window pops up:





Rotate the knob to select the right level and tap on the right soft key  to confirm the default setting.

 Tap on the left soft key  to return to the previous view.

8. BEFORE FIRST USE

 During installation or before first use you may observe some water in the machine. This is a residual water left in the machine after a full functional test in the factory to ensure the machine is delivered to customers in perfect working order and is no cause for concern.

1. Make sure that all transit bolts have been removed from the appliance.
2. Ensure that the electrical and water connections comply with the installation instructions.
3. Make sure to fill the AutoDose tanks with liquid detergent  and fabric softener . Refer to "AutoDose basic setting" paragraph in "The AutoDose technology" chapter.

4. Pour 2 litres of water inside the drum. This action activates the drain system.
5. Set and start a programme for cottons at the highest temperature without any laundry in the drum.

This removes all possible dirt from the drum and the tub.

9. THE AUTODOSE TECHNOLOGY (AUTODOSING)

i Read this chapter carefully.

9.1 Introduction

Right detergent and fabric softener dosage takes better care of the laundry and ensuring good wash performances.

Too much detergent damages your clothes and too little doesn't ensure good wash performances.

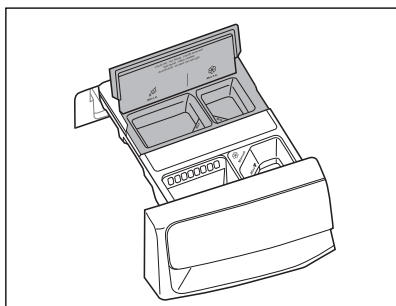

This appliance is equipped with an auto dosing system able to automatically provide the right detergent and fabric softener dosage to preserve the fabric integrity and colour brightness.





 AutoDose Liquid Detergent tank.

 AutoDose Fabric Softener tank.

The appliance is pre-set by the factory to suit most users habits.

Once started the programme, the appliance will automatically release the right amount of detergent and softener according to the real fabric load, if AutoDose is activated and the indicators  and/or  are visible on the display (detergent and softener indicators are showed only under Menu  view or just after start key press via a specific confirmation pop-up view).

i In some programmes, AutoDose is deactivated (the indicators  and/or  are not displayed and the display shows **OFF**) because there are garments requiring special detergents or treatments. If this is the case, pour the detergent and other treatments in the proper manual filling compartment.

Please refer to "AutoDose and options compatibility with programmes" in "Programmes" chapter.

i Further explanations on AutoDose and activation of advanced settings are available downloading our app.

9.2 Detergent dispenser with AutoDose tanks and manual compartments

i When using detergent and any other treatments, always follow the instructions that you find on the packaging of the detergent products. Anyway, we recommend not to exceed the maximum indicated level in each compartment (**MAX**).

If both AutoDose tanks are enabled in the set programme , liquid detergent and fabric softener are automatically loaded.

If one or both AutoDose tanks are disabled (OFF) in the set programme, proceed by manually filling in the proper manual compartment.

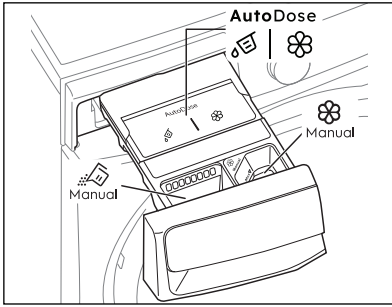

- | **AutoDose** tanks are for **liquid detergent** and **fabric softener** .

WARNING!

Do not put powder detergent in the AutoDose compartment.

- **Manual** compartment for **powder or liquid detergent**.
- **Manual** compartment for **liquid** additives (fabric softener, fabric conditioner, starch).
- **MAX** Maximum level for detergent/additives quantity.

9.3 AutoDose basic setting

The factory pre-set doses for a large load are 50 ml for detergent tank and 40 ml for fabric softener tank: the optimal configuration to meet majority of use condition. The appliance will use these settings to calculate the precise dosage for each wash based on load size.

However, under extreme conditions (very soft or very hard water) and particular type of detergent (such as super compact), we recommend to adjust the pre-set dosage by following the indication given on detergent and fabric softener container: e.g. when using super compact detergent you may need to reduce the pre-set dosage considerably.

If the washing results are not satisfying or there is too much foam during washing,

you may need to change the factory setting. Read in the paragraph 'AutoDose configuration mode' how to change the basic setting, but before:

1. Identifying the water hardness level.

Check the water hardness level in your area. The levels are generally indicated as: soft, medium and hard. If necessary, please contact your local water authority to check the water hardness in your area.

2. Identifying the customized detergent dosage.

Check the label in the detergent/fabric softener container and identify the quantity to use. For the detergent the suggested quantity of detergent is the combination of three different factors:

- Water hardness level;
- Normal soil level;
- Rated capacity of the appliance (e.g. maximum load capacity 11 kg). If the rated capacity on the product container refers to lower capacity appliances, the customized dosage should be increased by 20% referring to the proposed dosage.

As example for a machine with rated capacity 8 kg, medium water, normal soil level the dosage is recognised by the crossing in the detergent label dosages.

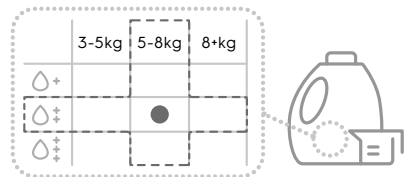



Water hardness levels



Levels	Water hardness range				
	°f ¹⁾	°d ²⁾	°e ³⁾	mmol/l	ppm
Soft	< 15	< 8	< 10	< 1,4	< 140
Medium ⁴⁾	15-25	8-14	0-17	1,5-2,5	150-250
Hard	> 15	> 14	> 17	> 2,5	> 250

- 1) French degrees
- 2) German degrees
- 3) English degrees
- 4) Factory setting, able to satisfy most of the use conditions.

9.4 AutoDose - Setup standard mode

1. Tap the On/Off button for a few seconds to activate the appliance.
2. Wait about 10 seconds for appliance internal check.
3. Tap the menu  button and turn the dial to navigate until AutoDose screen will appear.
The detergent tank icon  and the softener icon  are shown as ON.



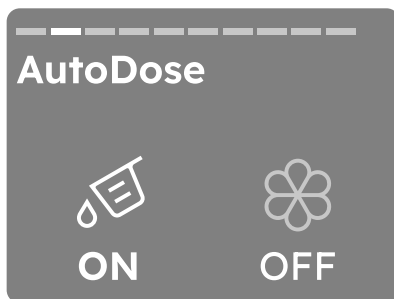

4. Tapping the left soft key , detergent tank could be enable/disable and set in ON or OFF mode. Otherwise, tapping the right soft key , softener tank could be enable/disable and set in ON or OFF mode.





After the first configuration, when starting a programme, the AutoDose pop-up will appear.

It can be dismissed by pressing "OK" tapping the right soft key  button.

If no action is taken, the pop-up will disappear after 7 seconds the machine will start and the user will see the running screen.

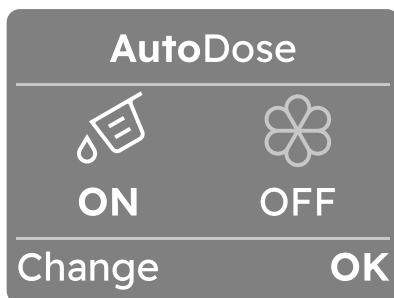
Pressing Change (tap left soft key  button) will take the user back to the AutoDose page in the menu. There, the user can toggle AutoDose on or off. The user then needs to press Start/Pause  to start the programme.





 If AutoDose is turned OFF in the settings, this pop-up is not shown.

9.5 AutoDose - Setup Linked mode

i To make this option available on the control panel, this function must be enabled in our app. If it is later disabled in our app, it is no longer available in the control panel.

In Linked mode the two compartments can be filled with the same detergent to increase capacity to run more cycles, from which compartment the detergent is dispensed is automatically handled by the appliance.

i If activated, this option will be remembered for each programme until it is changed by the user. This also applies if the user turns off the device or if a power failure occurs.

1. Tap the menu  button and turn the dial to navigate until AutoDose screen will appear
2. The detergent tank icon  is shown as ON.



3. Tapping the left soft key , detergent tank could be disabled and set in OFF mode.

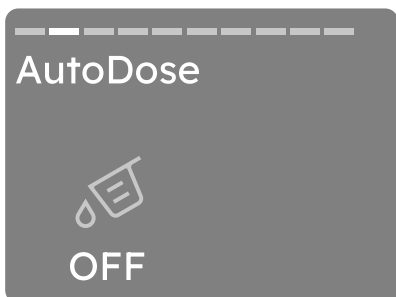

i If Linked Detergent is not available for a certain programme, the display will show "AutoDose OFF" and pressing the AutoDose key will generate an error sound and blink the "AutoDose OFF" symbols three times.

9.6 Filling the detergent and additives on AutoDose system

i Please read "Detergents and other treatments" in "Washing Hints" chapter.

i We recommend that you do not exceed the maximum indicated level (**MAX**).

1. Open the detergent dispenser.

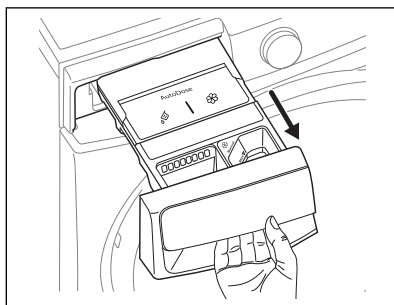

2. Lift up the AutoDose cover lid.

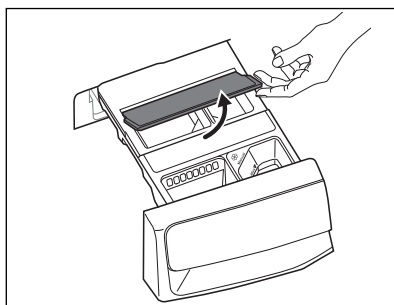

- Gently pour only liquid detergent in the AutoDose detergent tank . Fill up to the maximum indicated level **MAX**.

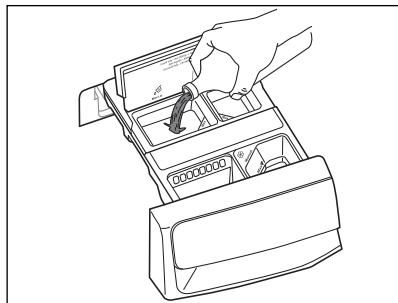

- Gently pour only liquid softener in the AutoDose fabric softener tank . Fill up to the maximum indicated level **MAX**.

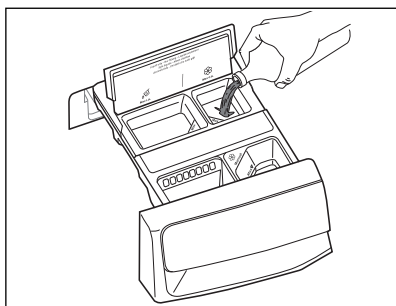

- Lift down the AutoDose cover lid.

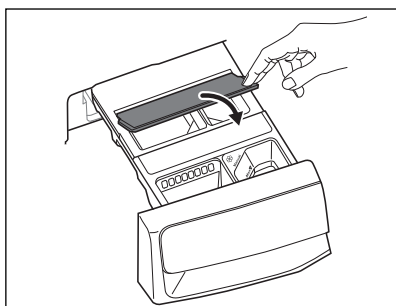

- Gently close the detergent dispenser, till click engagement.

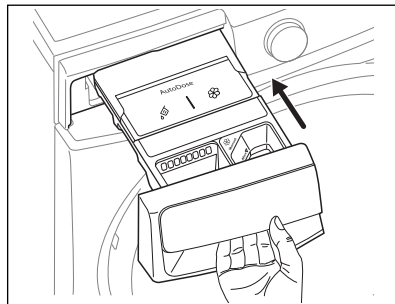

9.7 AutoDose low level indication

 Do not refill the AutoDose tanks unless appliance indicates that one or both tanks are empty.

When the activated tank reaches a low level of detergent, related indicator  appears on the display.

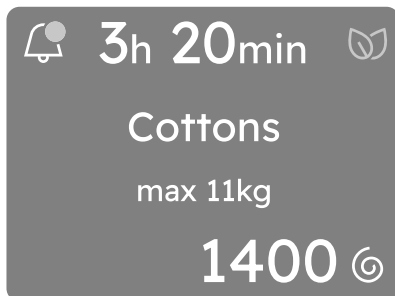

Notifications are often displayed at the end of cycle, but some messages also need to be displayed after the machine goes to standby and is powered on again.



Some notifications have actionable choices, like the tank refill that takes you to the AutoDose guide.

The display show clearly if is required the refill for detergent or softener.

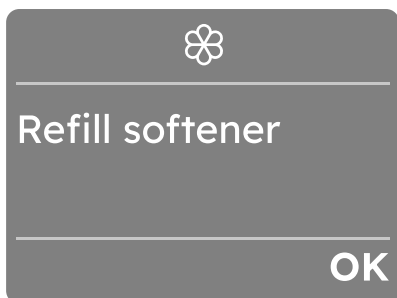
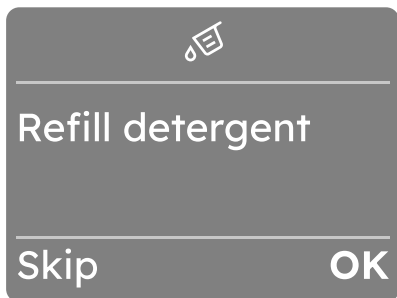

⚠ CAUTION!



The tanks refill must be carried out with the same brand and type of detergent/fabric softener/additive used before, otherwise clean the tanks before refilling.

i Notifications are dismissed once they are viewed, or if the user changes programme or turns the machine off.

9.8 Switching from AutoDose to manual dosing

It is possible to disable AutoDose function for one or both tanks by pressing related button symbol.

Example:

- To switch fabric softener tank off, press the right soft key  button, until the display shows OFF under softener icon .

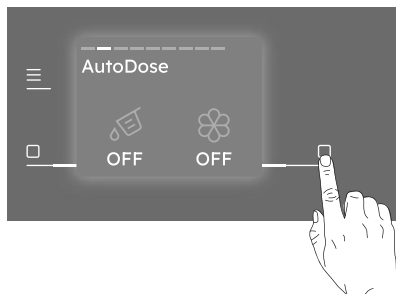

- If you need to use different detergent than ones present in AutoDose tanks, you could switch detergent tank off by pressing the left soft key button until the display shows OFF under detergent icon .

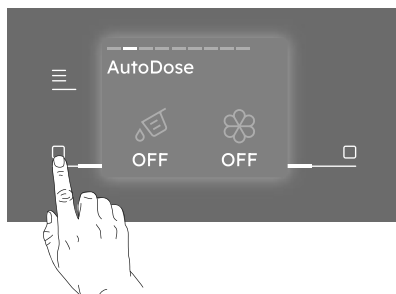

9.9 Manual filling the detergent and additives

You may need to use a different detergent or fabric softener than the ones used in the AutoDose tanks.

First, make sure that the AutoDose tanks are disabled and then pour the detergent and/or other treatments in the manual compartments.

i Do not exceed the maximum indicated level (**MAX**).

1. Open the detergent dispenser.

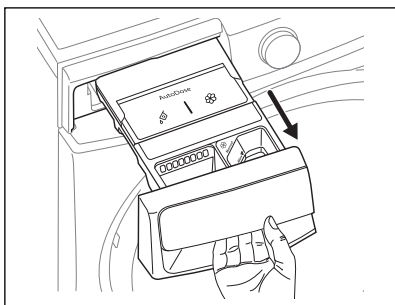

2. Put the powder or liquid detergent in the compartment.

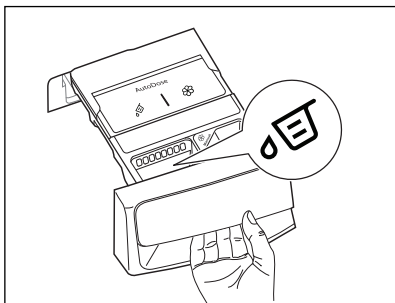
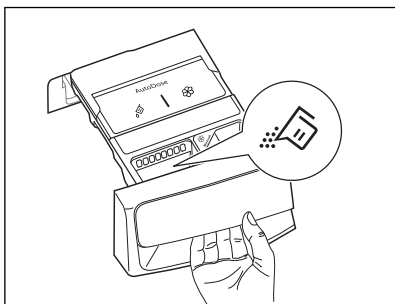

3. If desired, pour the fabric softener in the compartment  Manual .

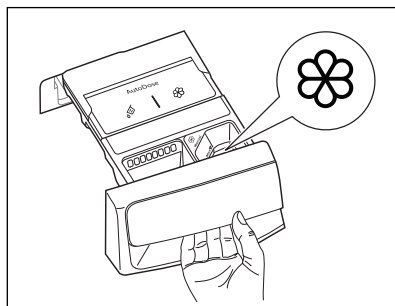

4. Gently close the detergent dispenser by pushing all the way in.

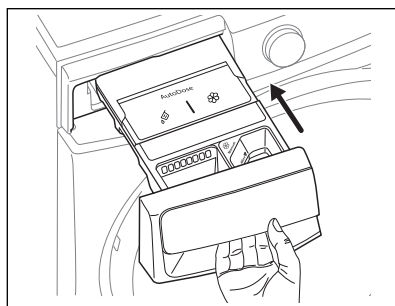

i If the machine has not been used for more than 4 weeks with filled tanks, detergent/softener can become viscous or dry out. It is needed to clean the drawer as indicated in "Care and Cleaning" chapter.

9.10 Drawer open indication

When a programme is running, the detergent drawer must always be closed.

A sensor in the drawer detects if the drawer is open (or not properly closed) while the programme is running. In such case, the appliance will immediately be paused.

If you press the Start/Pause  button, a specific popup view is showed indicating to close the drawer. Then the display returns to the previous paused state.

This will happen even if the user turned AutoDose off.

To restart the programme, ensure the drawer is properly closed and press Start/Pause  button.

10. PROGRAMMES

10.1 Programme Chart

Programme; Temperature range	Max. Spin speed (rpm)	Max. Load (Dry Clothes)	Type of load and soil level
Cottons; Cold to 90°C	1400	Max ¹⁾	White and coloured cotton.
Eco Cottons; 40°C and 60°C	1400	Max ¹⁾	Low-energy programme for cotton. Lowers temperature, extends duration.
IntelliQuick; Cold to 30°C	1200	Max ¹⁾	Daily wear coloured cotton clothes such as shirts, blouses, towels and undergarments. Ideal for normal level of soil.
Quick 15; Cold to 30°C	1200	1.5 kg	Small, lightly-soiled load. Cottons and synthetics
DelicatesPlus; Cold to 40°C	1200	4 kg	Protects fabric from pills or tears. For viscose, rayon, acrylic.
Denim; Cold to 40°C	1200	4 kg	Jeans and denim. Reduces fading.
 Wool; Cold to 40°C	1200	2 kg	Wool labelled "non-shrink, machine wash".
Bedding; Cold to 60°C	800	3 kg	Synthetic blankets, duvets and bedspreads
Sports; Cold to 40°C	1200	4 kg	Rinses and spins the laundry.
Baby Care; Cold to 40°C	1200	4 kg	Delicate cotton baby clothes and knitted items.
Towels; Cold to 90°C	1400	Max ¹⁾	Towels and bathrobes.

Programme; Temperature range	Max. Spin speed (rpm)	Max. Load (Dry Clothes)	Type of load and soil level
Sanitise; 60°C	1400	Max ¹⁾	White cotton items. This high-performance wash programme combined with steam vapour, removes more than 99,99% of bacteria and viruses ²⁾ keeping the temperature above 60°C throughout the washing phase; with an additional action on the fibres thanks to a vapour phase, an enhanced rinsing phase ensures a proper removal of detergent and micro-organism residues. This programme ensures also a proper reduction of pollens/allergenic items.
Easy Iron; Cold to 60°C	800	4 kg	Reduces creases for easier ironing.
Tub Clean; 60°C	-	-	Removes build-up and odours from drum.
Vapour Refresh	-	1.5 kg	Removes odours and creases with vapour only.
Rinse + Spin	1400	Max ¹⁾	Rinses and spins the laundry.
Spin	1400	Max ¹⁾	Spins and drains the laundry.

1) Maximum capacity depends on a sticker in front of the machine.
Model: EWF1142R9SC 11 kg









2) Tested for Staphylococcus aureus, Enterococcus faecium, Candida albicans, Pseudomonas aeruginosa and MS2 Bacteriophage in external test performed by Swissstat Testmaterialien AG in 2021 (Test Report No. 202120117).

Programme Options Compatibility

i The options are not selectable with all washing programmes, an option can exclude another one. In this case the appliance doesn't allow you to set the incompatible preference together.
Make sure the screen and the soft keys are always clean and dry.

i When you set a washing programme and enter the Menu  the display shows the available options.

Child Lock  and **Finish In**  are selectable with all programmes.

Options	Programme																
	Cottons	Eco Cottons	IntelliQuick	Quick 15	DelicatesPlus	Denim	Wool 	Bedding	Sports	Baby Care	Towels	Sanitise	Easy Iron	Tub Clean	Vapour Refresh	Rinse + Spin	Spin
SmartSelect 	<input type="checkbox"/>			<input type="checkbox"/>	<input type="checkbox"/>	<input type="checkbox"/>	<input type="checkbox"/>	<input type="checkbox"/>	<input type="checkbox"/>		<input type="checkbox"/>		<input type="checkbox"/>				
	<input type="checkbox"/>	<input type="checkbox"/>	<input type="checkbox"/>		<input type="checkbox"/>	<input type="checkbox"/>	<input type="checkbox"/>	<input type="checkbox"/>	<input type="checkbox"/>	<input type="checkbox"/>	<input type="checkbox"/>		<input type="checkbox"/>				
	<input type="checkbox"/>	<input type="checkbox"/>			<input type="checkbox"/>	<input type="checkbox"/>		<input type="checkbox"/>	<input type="checkbox"/>	<input type="checkbox"/>	<input type="checkbox"/>	<input type="checkbox"/>	<input type="checkbox"/>				
 No Spin	<input type="checkbox"/>	<input type="checkbox"/>	<input type="checkbox"/>	<input type="checkbox"/>	<input type="checkbox"/>		<input type="checkbox"/>	<input type="checkbox"/>	<input type="checkbox"/>	<input type="checkbox"/>	<input type="checkbox"/>					<input type="checkbox"/>	<input type="checkbox"/>
 Rinse Hold	<input type="checkbox"/>	<input type="checkbox"/>	<input type="checkbox"/>	<input type="checkbox"/>	<input type="checkbox"/>	<input type="checkbox"/>			<input type="checkbox"/>	<input type="checkbox"/>	<input type="checkbox"/>		<input type="checkbox"/>			<input type="checkbox"/>	
 Refresh	<input type="checkbox"/>	<input type="checkbox"/>	<input type="checkbox"/>	<input type="checkbox"/>	<input type="checkbox"/>	<input type="checkbox"/>		<input type="checkbox"/>	<input type="checkbox"/>	<input type="checkbox"/>	<input type="checkbox"/>						
 Prewash	<input type="checkbox"/>	<input type="checkbox"/>			<input type="checkbox"/>				<input type="checkbox"/>	<input type="checkbox"/>	<input type="checkbox"/>		<input type="checkbox"/>				
SensorWash ¹⁾	<input type="checkbox"/>				<input type="checkbox"/>			<input type="checkbox"/>	<input type="checkbox"/>	<input type="checkbox"/>	<input type="checkbox"/>						
Hygienic Care ²⁾	<input type="checkbox"/>	<input type="checkbox"/>			<input type="checkbox"/>			<input type="checkbox"/>		<input type="checkbox"/>	<input type="checkbox"/>				<input type="checkbox"/>		
Stain Pro ³⁾	<input type="checkbox"/>	<input type="checkbox"/>			<input type="checkbox"/>	<input type="checkbox"/>		<input type="checkbox"/>		<input type="checkbox"/>	<input type="checkbox"/>						
 Finish In	<input type="checkbox"/>	<input type="checkbox"/>	<input type="checkbox"/>	<input type="checkbox"/>	<input type="checkbox"/>	<input type="checkbox"/>	<input type="checkbox"/>	<input type="checkbox"/>	<input type="checkbox"/>	<input type="checkbox"/>	<input type="checkbox"/>	<input type="checkbox"/>	<input type="checkbox"/>		<input type="checkbox"/>	<input type="checkbox"/>	<input type="checkbox"/>
 AutoDose Detergent	<input type="checkbox"/>	<input type="checkbox"/>	<input type="checkbox"/>	<input type="checkbox"/>	<input type="checkbox"/>	<input type="checkbox"/>		<input type="checkbox"/>	<input type="checkbox"/>	<input type="checkbox"/>	<input type="checkbox"/>	<input type="checkbox"/>	<input type="checkbox"/>				
 AutoDose Softener	<input type="checkbox"/>	<input type="checkbox"/>	<input type="checkbox"/>	<input type="checkbox"/>	<input type="checkbox"/>	<input type="checkbox"/>	<input type="checkbox"/>	<input type="checkbox"/>	<input type="checkbox"/>	<input type="checkbox"/>	<input type="checkbox"/>	<input type="checkbox"/>	<input type="checkbox"/>			<input type="checkbox"/>	

1) SensorWash is always on. The machine will automatically check the dirt level and detergent residue* in your laundry when using this option. It will automatically adjust the washing time and number of rinses according to the load to ensure your clothes are clean. An affected to increase or decrease in the operating time of the machine.

2) "Hygienic Care" option can be with temperature 40 to 90°C only.

3) "Stain Pro" option can be combined with temperature 40 to 90 °C only.

10.2 More Programmes

Programme; Temperature range	Max. Spin speed (rpm)	Max. Load (Dry Clothes)	Type of load and soil level
Outdoor; Cold to 40°C	1200	2.5 kg	Outdoor clothing, technical, sport fabrics, waterproof and breathable jackets, shell jackets with a removable fleece or inner insulation. The recommended laundry load is 2.0 kg. This programme can also be used as water repellent restoring phase, specifically tailored for treating clothes with a hydrophobic coating. To perform the water repellent restoring phase, proceed as follows: <ul style="list-style-type: none"> • Pour the washing detergent in the compartment . • Pour a special water repellency restorer for fabric in the drawer compartment for fabric softener Manual .
Work Wear; Cold to 90°C	1400	Max ¹⁾	Overalls, dungarees and working clothes. Intensive cycle with a prewash phase to remove dirt and solid soils.
Mixed; Cold to 60°C	1200	4 kg	Synthetic items or mixed fabric items. Normally soiled items.
Curtains; Cold to 40°C	800	4 kg	Delicate cycle with pre-wash to remove dust from curtains.
Soft Toys; Cold to 40°C	800	4 kg	Delicate drum movements and rinsing suited for soft toys.
Silk; 30°C	800	0.5 kg	Machine, hand washable silk and other delicate fabrics.
Pillow; Cold to 40°C	800	3 kg	Designed for 2 sofa pillows or 1 bed pillow. It is recommended to wash bed pillows with own pillowcase.
Pet Hair; Cold to 60°C	1200	2 kg	Washing programme tailored for removing pet hair from items









1) Maximum capacity depends on a sticker in front of the machine.
Model: EWF1142R9SC 11 kg

Programme Options Compatibility

i The options are not selectable with all washing programmes, an option can exclude another one. In this case the appliance doesn't allow you to set the incompatible preference together.
Make sure the screen and the soft keys are always clean and dry.

i When you set a washing programme and enter the Menu  the display shows the available options.

Child Lock  and **Finish In**  are selectable with all programmes.

Options	Programme							
	Outdoor	Work Wear	Mixed	Curtains	Soft Toys	Silk	Pillow	Pet Hair
QuickSelect 	■		■		■		■	
	■	■	■	■	■	■	■	
		■	■	■	■		■	■
 No Spin	■	■	■	■	■			
 Rinse Hold	■	■	■	■	■			■
 Refresh		■	■					
 Prewash			■		■			■
SensorWash ¹⁾	■	■	■	■	■			
Hygienic Care ²⁾			■					
Stain Pro ³⁾			■					
 Finish In	■	■	■	■	■	■	■	■
 AutoDose Detergent	■	■	■	■	■			■
 AutoDose Softener		■	■	■	■	■	■	■

- 1) SensorWash is always on. The machine will automatically check the dirt level and detergent residue* in your laundry when using this option. It will automatically adjust the washing time and number of rinses according to the load to ensure your clothes are clean. An affected to increase or decrease in the operating time of the machine.
- 2) "Hygienic Care" option can be with temperature 40 to 90°C only.
- 3) "Stain Pro" option can be combined with temperature 40 to 90 °C only.

10.3 Woolmark Apparel Care - Blue



The wool wash cycle of this machine has been approved by The Woolmark Company for the washing of wool garments labelled as "hand wash" provided that the products are washed according to the instructions on the garment label and those issued by the manufacturer of this washing machine.

M1361

11. WI-FI CONNECTIVITY SETUP

i The software in this product contains components that are based on free and open source software. Electrolux gratefully acknowledges the contributions of the open software and robotics communities to the development project. To access the source code of these free and open source software components whose license conditions require publishing, and to see their full copyright information and applicable license terms, please visit: <http://electrolux.pensoftwarerepository.com> (folder NIUS)

This chapter describes how to connect the smart appliance to the Wi-Fi network and to link it to a mobile device.

By this functionality you can receive notifications, control and monitor your appliance from your mobile devices.

The Wi-Fi functionality is off as factory default setting.

To connect the appliance to enjoy the full range of features and services you need:

- Wireless network at home with internet connection enabled.
- Mobile device connected to wireless network.

Wi-Fi module parameter

Frequency/ Protocol	Wi-Fi: 2.4 GHz / 802.11 bgn
Max Power	Wi-Fi 2.4 GHz: < 20 dBm
Encryption	WPA, WPA2, WEP

11.1 Download, installing, and configuring our app

i Minimum requirements: iPhone6/ iOS 9.3/Android 5.1 and above. You will need to install our app, create an account, and accept the Terms and Conditions and Electrolux's Privacy Policy in the app to use the connected features of the laundry appliance. Internet and Wi-Fi connections are required to use the full features of the App and the laundry appliance. Minimum requirements, apps, and services are subject to change without notice.

1. Go to the App Store/Play Store, download and install our app on your smart device.





2. Create an account. This account can be shared across multiple devices.
3. Follow the instructions on our app for the appliance registration and configuration.

i Our app allows you to control your laundry through a mobile device. It contains a large number of programmes, useful features and product information tailored perfectly to the appliance. Through our app you can select the programmes already available from the appliance control panel, plus unlock additional programmes available only from a mobile device. Additional programmes can change over the time along with new versions of the app. It's personalized laundry care - all from your mobile device.

11.2 Wi-Fi appliance connection

Tap the On/Off button for a few seconds to activate the appliance.

To connect the appliance to a Wi-Fi network, tap and hold the Remote Start Mode  key button for 5 seconds. It is also possible to enable Wi-Fi from the machine settings menu.

During this phase, the display shows Wi-Fi  icon and "**Starting up...**" message. After a while "**Ready to connect**" message and icon  appear.

Connecting your appliance

 Before proceeding with next steps, be sure that our app has been downloaded and configured and you smart device connected to your home network. Refer to "Download, installing, and configuring our app" paragraph.

Open our app from your smart device and follow the instruction displayed to add your appliance.

During association phase, Our app could redirects to the smart device Wi-Fi settings to select the home network and requires to enter the Wi-Fi password to connect the appliance.

After **Connecting...** phase, if successfully concluded, "**Connected**" message is shown. Otherwise, the message "**Not connected**" is displayed.

Once connected, tapping on the Remote Start  Mode key button on will enable users to be able to start cycles remotely on our app.

Auto connection to registered network

Once the appliance has been successfully set-up and registered to the home network, every time it is powered on, it will try to connect to the network automatically. There will not be any sound when Wi-Fi connection is successful.

Connecting to a different network (Reopening Access Point)

Every time user tap and hold Remote Start Mode  key button for 5 seconds, the access point will be open and broadcasted. New network credentials received at this point will overwrite previously saved credentials, and the appliance then connects to the new Wi-Fi network.

Refer to "Connection your appliance" section to perform the connection.

Turning Off Wi-Fi

If the user decides to no longer connect the appliance to Wi-Fi, he can tap and hold Remote Start  Mode key button for 10 seconds and the appliance will reset and turn off. It is also possible to disable Wi-Fi from the settings menu.

After confirming the reset the display shows the message "**Network is reset**" and the Wi-Fi is set off.

11.3 Over-the-air update

Application may propose an update for your appliance.

If a programme is running, our app notifies that the update will start at the end of the programme.

During the update, the appliance shows a message in the display.

Do not switch off or unplug the appliance during update.

The appliance will be usable again at the end of the update, without any notification about successful update.

If an error occurs, the appliance shows a message in the display: just press any buttons or turn the knob to return to normal use.

11.4 Wi-Fi Always On

The Wi-Fi Always On function is available in our app.

This function keeps the appliance connected to the network even when the appliance is turned off.

Wi-Fi  icon is on.

The icon blink, Machine can't connect the network.

It is possible to turn the appliance on by pressing the On/Off button or through our app.

 The Wi-Fi Always On function may affect your energy consumption.



12. OPTIONS

12.1 Introduction

Several additional options are available for each programme. Check compatibility in the programme table section.



 After 10 seconds of inactivity the displays shows the home screen with selected programme.

12.2 Soft Key options

After selecting a programme, it is possible to change the default Temperature  and Spin  set.

To modify the **Temperature**  tap the left soft key :

- The default temperature shown will decrease to the minimum expected for the selected cycle.
- Continue pressing and the sequence will proceed from the maximum expected temperature.

 If Temperature  setting is not available, left soft key led will be off.

To modify the **Spin**  tap the right soft key :

- The default spin shown will decrease to the minimum expected for the selected cycle.
- Continue pressing and the sequence will proceed from the maximum expected spin.

 If only one option is available, right soft key led will be off.

12.3 Prewash

Use this option to add a pre-wash phase at 30 °C before the washing phase.

This option is recommended for heavily soiled laundry, especially if containing sand, dust, mud and other solid particles.

Tap on the **Menu**  soft key, rotate the dial until the display shows the Prewash option.

To **activate/deactivate** this option:

- Tap the right soft key  and the relevant indicator will turn On/Off.

 Prewash remain active also after machine switch off and on and set by default in programme where available. The option can increase the programme duration.

12.4 Stain Pro

Select this option to add an anti-stain phase to a programme in order to treat heavily soiled or stained laundry with stain remover.

Pour the stain remover into compartment. The stain remover will be added in the appropriate phase of the washing programme.

Tap on the **Menu**  soft key, rotate the dial until the display shows this option.

To **activate/deactivate** this option:

- Tap the right soft key  and the relevant indicator will turn On/Off.

 This option is not available with a temperature lower than 40 °C.

The option can increase the programme duration.

12.5 Hygienic Care

Select this option to add approximately 30 minutes of tumbling in vapour after the rinse cycle. The indicator of this option will be on.

- Vapour may not necessarily be visible inside the drum during a vapour cycle. Vapour is created below the drum and allowed to naturally rise into the clothes.
- At the end of the Vapour cycle, the clothes will be warmer, softer and detached from the drum.

Tap on the **Menu**  soft key, rotate the dial until the display shows this option.

To **activate/deactivate** this option:

- Tap the right soft key  and the relevant indicator will turn On/Off.

 If Vapour option is selected, rinse temperatures will be elevated. During a vapour cycle, you may notice vapour exiting from the drain hose of the machine, this is normal and there is no cause for alarm.

12.6 Finish In

With this option you can set the time to end of the selected cycle.

 The proposed time to finish in is always higher than the programme duration.

To **activate** this option:

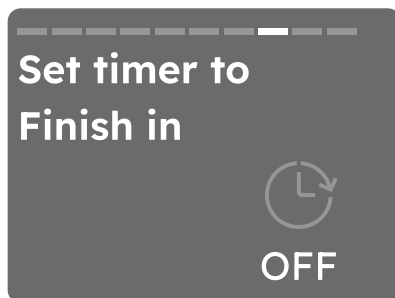

- Tap on the **Menu**  soft key, rotate the dial until the display shows the Set timer to finish in.



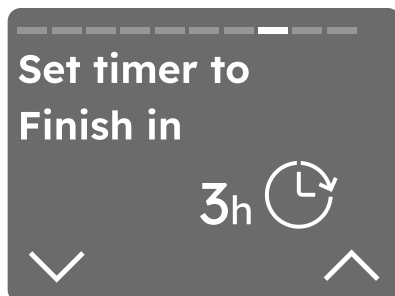

- You can activate this option by pressing the right soft key . The display shows the hours of the time to end starting from 3 hours. (This option makes it possible to define the end of the washing programme from minimum of 1 hour to maximum of 24 hours.)

 If programme duration is longer than 2 hours, minimum Finish In option starts from 3 hours.

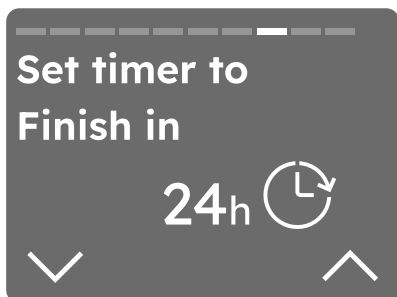

- Pressing the right soft key  next to  it is possible to increase the time by one hour with each tap, up to 24 hours.



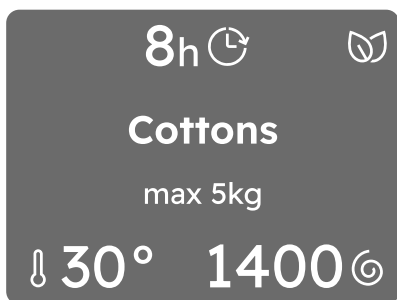

- If you want to decrease time tap the left soft key  next to , the duration will be reduced by one hour with each tap.
- Once you have selected the desired timer wait 3 seconds and you will be redirected to the home screen where at the top of the display you will be able to see the countdown.



 The appliance keeps the selection of this option after you switch it off.

To **remove** the Finish In option:

- Navigate through the **Menu**  to the Finish In option.
- Reduce the time by pressing the left soft key  until the display shows OFF.



12.7 Child Lock

With this option you can prevent the children from accidentally operating the appliance.

To **activate** this option:

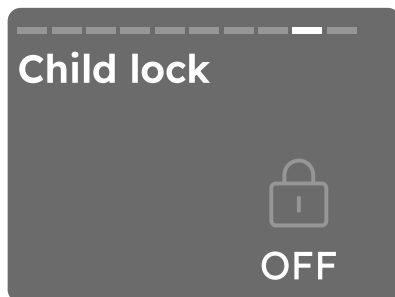
- Tap on the **Menu**  soft key, rotate the dial until the display shows the Child lock.



- You can activate this option by tapping the right soft key . (The screen back to the selected programme with the child lock icon  appear.)
- After you have activated the options soft keys and the touch screen are deactivated. It is possible to turn the appliance off by means of the On/Off button.
- Before pressing the Start/Pause button the appliance cannot start.

The display shows the icon Child Lock in the middle of the display.

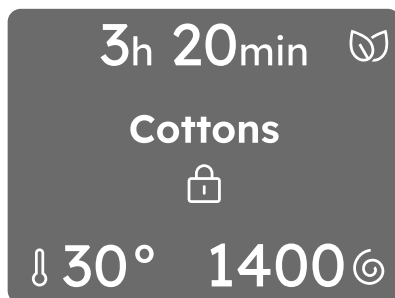



 The appliance keeps the selection of this option after you switch it off.

To **deactivate** this option:

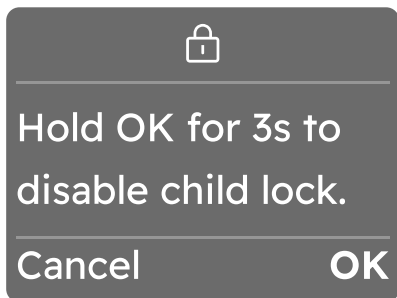
- Tap the right soft key , then press and hold for 3 seconds. A countdown will be visible in the display in the lower right corner.



 Once the option is deactivated child lock icon  goes off and the display will show the information as before activation.





12.8 Favourite

How to set a favourite cycle

Up to three favourite cycles can be saved.

 There are no favourite cycles saved by default.



To **save** you favourite cycle:

- Select programme and setting temperature, spin speed, and options.
- Tap on the **Menu**  soft key, rotate the dial until the display shows the **Save as favourite**, tapping the right soft key  to entry.
- Rotate the dial to select one of the three empty fields and tapping the right soft key  to select and saved.
- After two seconds, the display will show the selected cycle as a favourite recognizable by a heart at the top of the screen.

 When you want to save the next favourite the first empty slot will be indicated automatically.

How to replace a favourite cycle

It is possible to replace favourites:

- Select new programme and setting temperature, spin speed, and options.
- Tap on the **Menu**  soft key, rotate the dial until the display shows the **Save as favourite**, tapping the right soft key  to entry.
- Turn dial to select one of the three fields to be overwritten.
- Confirm the row by tapping the right soft key .
- After two seconds, the display will show the selected cycle as a favourite recognizable by a heart at the top of the screen.

It is not possible to **delete** you favourite cycle on the appliance.

 In order to delete favourites it is necessary to perform a factory reset of the appliance or by our app.

How to access the favourites cycle

To access the favourites from programmes list rotate the dial to the left.

i If the fields are occupied the first favourite cycle will be displayed, then the second and eventually the third.

i If the fields are empty, a suggestion on how to save new favourites will be displayed.

13. SETTINGS

13.1 Machine Setting

In this part are explained the main settings of the appliance.

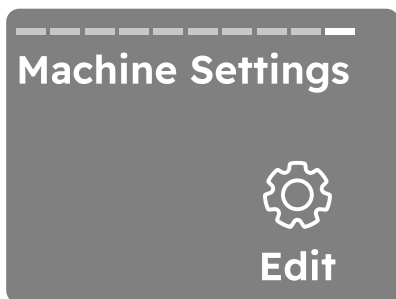

Tap on the right soft key  Edit , to access the settings.





i After 10 seconds of inactivity the displays shows the home screen with selected programme.

AutoDose

For AutoDose functionality refer to the specific paragraph.

13.2 Language setup

It is possible to **change the display language** by

- Select the Language menu, tap right soft key  to select to go to select the language. Select the language by rotate the dial then tap right soft key  to Select.
- Go back  to the previous view and tap the Menu  soft key to main screen.

i By turning the knob the selected language will be visible in bold.

13.3 Wi-Fi

With this option you edit Wi-Fi settings.

Tap on the right soft key  to access the settings. You can:

- Enable Wi-Fi network.
- Connecting to a different Wi-Fi network.
- Disable Wi-Fi network.

i For more details refer to "Wi-Fi - Connectivity setup" chapter

13.4 Water Hardness

With this setting you can change the Water Hardness level.

To **modify** the level:

- Tap the right soft key next to \wedge or left soft key next to \vee visualize the levels:
 - a. Hard
 - b. Medium
 - c. Soft
- Select the desired level by tapping the right or left soft key .
- Tapping Menu \equiv soft key confirm setting.

 A few seconds, the displays shows the home screen with selected programme.

13.5 Ultramix

This option eliminates detergent residue on fabrics.

To **activate/deactivate** the option:

- Tap the right soft key and the relevant indicator will turn ON /OFF.

Rotate the dial to move to the next setting.

13.6 SensorWash

Intelligently assesses the dirt and detergent residue in your laundry. The SensorWash adjusts the washing time and rinse cycles to match the load. This not only ensures optimal cleanliness but also helps prevent damage to your clothes, thereby extending their lifespan.

To **activate/deactivate** the option:

- Tap the right soft key and the relevant indicator will turn ON /OFF.

Rotate the dial to move to the next setting.

 If turning off, may affect the efficiency of your washing cycle.

13.7 Save last used

Save the last used by enable.

To **activate/deactivate** the option:

- Tap the right soft key and the relevant indicator will turn ON /OFF.

Rotate the dial to move to the next setting.

To **ON** this option, the last used programme automatic saved.



How to access the last used programme

To access the Last used by rotate the dial to the left after you power on the appliance.



13.8 Button sounds

With this setting you can turn off the sound of the buttons.

To **activate/deactivate** the sounds:

- Tap the right soft key and the relevant indicator will turn ON  / OFF .





Rotate the dial to move to the next setting.

 The sound of the On/Off  button cannot be disabled

13.9 End alert

With this setting you can change the Cycle End Alarm.

To **activate/deactivate or modify** the sounds:



- Tap the right soft key next to \wedge or left soft key next to \vee visualize the levels:
 - a. Long 
 - b. Medium 
 - c. Short 
 - d. OFF 
- Tapping Menu \equiv soft key confirm setting.

 A few seconds, the displays shows the home screen with selected programme.

13.10 Display Brightness

With this setting you can change the Display Brightness.

To **modify** the level:

- Tap the left soft key next to  indicator to decrease brightness.
- Tap the right soft key next to  indicator to increase brightness.

Rotate the dial to move to the next setting.

 There are five brightness levels available.



13.11 Guides

With this option you can see brief explanations of some features.

Rotate the programme dial and select by tapping the right soft key  one of the following option:



- **Introduction:** Learn about the control panel, the SmartSelect, Vapour refresh, Dryness level, Time dry, Menu, Left/right buttons, Remote start.

- **AutoDose:** guide about detergent and softener.
- **Wi-Fi:** information about the on boarding.

 Go back  to the previous view by tapping the left soft key .

13.12 Settings reset to factory default

With this setting you can reset your appliance to the factory settings.

1. Tap on the right soft key  to enter the option.
2. Tap on the left soft key  to Cancel.
3. Tap on the right soft key  to confirm the reset.

Performing the reset will take a few seconds.

 Settings reset to factory default deletes permanent options and favourites saved.

14. DAILY USE

WARNING!

Refer to Safety chapters.

14.1 Before activating the appliance

1. Make sure that the mains plug is connected to the mains socket.
2. Make sure that the water tap is open.

14.2 Activating the appliance

1. Open the water tap
2. Press the On/Off  button a few seconds to activate the appliance.

14.3 Activating the appliance

Press the On/Off  button to turn the appliance on. A tune sounds.

The default at first switch on is Cottons programme.

The information of the selected programme are visible in the display. The led of the Start/Pause key button flashes.

14.4 Setting a programme

The Cottons is the default proposed programme when the appliance is turned on.

1. Turn the programme dial to set the desired programme.
After a few seconds the display shows programme summary view with the following information:

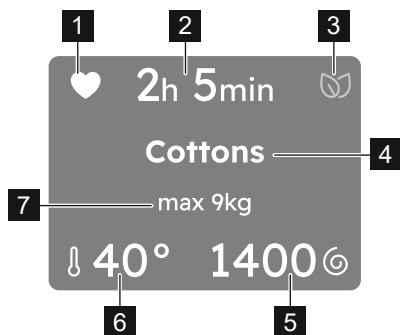

1. Favourite, if already saved.
2. Programme duration
3. SmartLeaf
4. Selected programme
5. Spin speed
6. Temperature
7. Maximum programme load

i Also additional options, if activated, will be visible in the display.

Tap on the different soil level of the SmartSelect to the right on the control panel.

Vapour Refresh programme can be selected in the SmartSelect area.

i Every time a different SmartSelect level is chosen it will be visible for 2 seconds in the display.

You can also:

1. Tap on the left soft key to change the **Temperature** .
2. Tap on the right soft key to change the **Spin** speed.
3. Tap on **Menu** to enter the additional available options and set one or more of them.

14.5 Loading the laundry

- Open the appliance door.
- Shake the items before you put them in the appliance.
- Put the laundry in the drum, one item at a time.

Make sure not to put too much laundry in the drum.

- Close the door firmly.

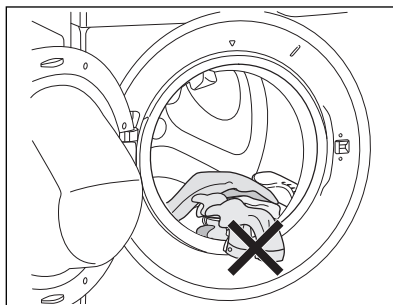

CAUTION!

- Make sure that no laundry stays between the seal and the door. There is a risk of water leakage or damage to the laundry.
- Washing heavily oiled, greasy stains could cause damage rubber parts of the appliance.

14.6 Using detergent and other treatments

If both AutoDose tanks are enabled (ON) in the set programme, detergent and fabric softener are automatically loaded.

If one of the AutoDose tank or both are disabled (OFF) in the set programme, proceed by manually filling the product in the proper compartment.

14.7 Starting a programme

WARNING!

Make sure that the detergent dispenser is firmly closed, otherwise programme won't start.

Touch the Start/Pause  key button to start the programme.

The related indicator stops flashing and stays on.



The programme starts, the door is locked.

The display shows the icon .

 The drain pump can operate shortly before the appliance fills water.



14.8 Interrupting a programme and changing the options

When the programme is running, you can change **only some** options:

1. Touch the Start/Pause  key button. The related indicator flashes.
2. Change the options. The given information in the display changes accordingly.
3. Touch the Start/Pause  key button again.

The washing programme continues.

14.9 Cancelling a running programme

1. Press the On/Off  button to cancel the programme and to deactivate the appliance.
2. Press the On/Off  button again to activate the appliance.

Now, you can set a new washing programme.

 The water and the detergent are not drained out in order to avoid waste. The display shows the maximum duration of the programme, updating it about 20 minutes after the starting of the new programme.



14.10 Opening the door - Adding garments

If a message in the display that inform you that you can add or remove garments, you can always open the door.

While a programme or the delay start operates, the appliance door is locked. The display shows the icon .

 If the temperature and level of the water in the drum are too high and/or the drum is still rotating you **should not open the door**.

To add or to remove garments:

1. Touch the Start/Pause  key button. In the display the related door lock icon  goes off.
2. Open the appliance door. If necessary, add or remove the garments. Close the door and touch the Start/Pause  key button.

The programme or the Finish In continues.

14.11 End of the programme

When the programme has finished, the appliance stops automatically. The acoustic signals operate (if they are active). The display shows Done, the completed line of progress and Remove Garments message.

The indicator of the Start/Pause  key button goes off.

The door unlocks and the indicator  goes off.

1. Press the On/Off  button to deactivate the appliance.



After five minutes from the end of the programme, the energy saving function automatically deactivates the appliance.

 Depend on last use option is on/off. If ON, the display shows at the last use programmes. But OFF, the display shows Cottons programme. Turn the programme dial to set a new cycle.

2. Remove the laundry from the appliance.
3. Make sure that the drum is empty.
4. Keep the door and the detergent dispenser slightly open to prevent mildew and odours.



14.12 Draining water out after end of cycle

If you have chosen a programme or an option that does not empty out the water of the last rinse, the programme is completed, but:

- Draining phase is shown in the display and the door is locked .
- The indicator of the Start/Pause  key button starts flashing.
- The drum still turns at regular intervals to prevent creases in the laundry.
- The door stays locked.
- You must drain the water to open the door.

14.13 Stand-by function

The Stand-by function automatically deactivates the appliance to reduce the energy consumption when:

- You do not use the appliance for 5 minutes when no programme is running.
 - Press the button On/Off  to activate the appliance again.
- 5 minutes after the end of the washing programme.
 - Press the On/Off  button to activate the appliance again.
 - The display shows the end of the last programme.
 - Turn the programme dial to set a new cycle.

 If you set a programme or an option that ends with water in the drum, the Stand-by function **doesn't deactivate** the appliance to remind you to drain the water.

 If the Wi-Fi Always On function is active, only the indicator  goes on.

15. WASHING HINTS AND TIPS

15.1 Sorting The Laundry

Follow the wash code symbols on each garment label and the manufacturer's washing instructions. Sort the laundry as follows: whites, coloureds, synthetics, delicates, woollens.

15.2 Temperatures

Temp	Soil level
90°C	For normally soiled white cottons and linen (e.g. tea cloths, towels, tablecloths, sheets...).
60°C 50°C	For normally soiled, colourfast garments (e.g. shirts, night dresses, pyjamas...) in linen, cotton or synthetic fibres and for lightly soiled white cotton (e.g. underwear).
40°C 30°C Cold	For delicate items (e.g. net curtains), mixed laundry including synthetic fibres and woollens bearing the label pure new wool, machine washable, non-shrink.

15.3 Before Loading The Laundry

- Make sure that no metal objects are left in the laundry (e.g. coin, hair clips, safety pins, pins).



- Button up pillowcases, close zip fasteners, hooks and poppers. Tie any belts or long tapes.



- Wash bras, pantyhose and other delicates in a mesh laundry bag, which you can purchase from your supermarket.
- Make sure that you wash lint collectors separately from lint producers.
- Never wash whites and coloured fabrics together. Whites may lose their "whiteness" in the wash. New coloured items may run in the first wash; they should therefore be washed separately the first time.
- Remove persistent stains before washing.
- Rub particularly soiled areas with a special detergent or detergent paste. Treat curtains with special care. Remove hooks or tie them up in a bag or a net.

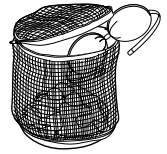

15.4 Maximum Loads

Recommended loads are indicated in the chapter "Programmes"

General rules:

Clothes Load	Quantity
Cottons, linen	drum full but not too tightly packed;
Synthetics	drum no more than half full;
Delicate fabrics and woollens	drum no more than one third full.

Washing a maximum load makes the most efficient use of water and energy. For heavily soiled laundry, reduce the load size.

15.5 Removing Stains

Stubborn stains may not be removed by just water and detergent. It is therefore advisable to treat them prior to washing.

Blood: treat fresh stains with cold water. For dried stains, soak overnight in water with a special detergent then rub in the soap and water.

Oil based paint: moisten with benzine stain remover, lay the garment on a soft cloth and dab the stain; treat several times.

Dried grease stains: moisten with turpentine, lay the garment on a soft surface and dab the stain with the fingertips and a cotton cloth.

Rust: oxalic acid dissolved in hot water or a rust removing product used in cold water. Be careful with rust stains which are not recent since the cellulose structure will already have been damaged and the fabric tends to hole.

Mould stains: treat with bleach, rinse well (whites and fast coloureds only). Grass: soap lightly and treat with bleach (whites and fast coloureds only).

Ball point pen and glue: moisten with acetone (*), lay the garment on a soft cloth and dab the stain.

Lipstick: moisten with acetone (*) as above, then treat stains with methylated spirits. Remove any residual marks from white fabrics with bleach.

Red wine: soak in water and detergent, rinse and treat with acetic or citric acid, then rinse. Treat any residual marks with bleach.

Ink: depending on the type of ink, moisten the fabric first with acetone (*), then with acetic acid; treat any residual marks on white fabrics with bleach and then rinse thoroughly.

Tar stains: first treat with stain remover, methylated spirits or benzine, then rub with detergent paste.

(*) do not use acetone on artificial silk.

15.6 Detergents Type and Quantity

Low suds detergent is required for this machine to prevent over suds problems, unsatisfactory washing result and harm to the machine.

Low suds detergents designed for front load washing machines are labelled "Front Loading", "High Efficiency", "HE", such as Cold Power for Front Loaders or "Matic".

Do not use wrong types of detergent, such as Top Loading, Hand wash detergent or Soap-Based products in your front load washing machine. This can result in excessive suds, longer cycle time, low spin speeds, poor rinsing and overloading of the motor.

Quantity of detergent to be used

The choice of detergent and use of correct quantities not only affects your wash performance, but also helps to avoid waste and protect the environment.

Although biodegradable detergents contain substances which in large quantities can upset the delicate balance of nature.

The choice and quantity of detergent will depend on ;

- type of fabric (delicates, woollens, cottons, etc.);
- the colour of clothes;
- size of the load;
- degree of soil;
- wash temperature ; and
- hardness of the water used.

Water hardness is classified by so-called "degrees" of hardness.

Information on hardness of the water in your area can be obtained from the relevant water supply company, or from your local authority.

You may have to try using the detergent quantity as per manufacturers' instructions then compare the wash result to the list below and adjust the amount of detergent for your future washes accordingly.

Not enough detergent causes:

- the wash load to turn grey,
- greasy clothes.





Too much detergent causes:

- over suds,
- reduced washing effect,
- inadequate rinsing.

Use less detergent if:

- you are washing a small load,
- the laundry is lightly soiled,
- large amounts of foam during washing.

15.7 Saving tips

 Let the SmartSelect function guide you to save energy and water. Light  and Normal  options can be used the most of the time. Use Vapour Refresh , to avoid washing and refresh your clothes with only steam.

For better result we recommend that you follow these tips:

- **Normally soiled laundry** may be washed without prewash in order to save detergent, water and time.
- Loading the appliance to the **maximum capacity indicated for each programmes helps to reduce energy and water consumption.**
- With adequate pre-treatment, stains and limited soiling can be removed; the laundry can then be washed at a lower temperature.
- To use the correct quantity of detergent, refer to the quantity suggested by the detergent producer and check the water hardness of your domestic system. Refer to 'Water hardness'.
- If you have a tumble dryer its suggested to use maximum possible spin speed for the selected washing programme in order to save energy during drying.
- Preferably, use short cycles at lower temperatures.

15.8 Water hardness

If the water in your area is hard or medium hard, we recommend that you use a water softener for washing machines.

The water is hard or medium hard when the hardness exceeds 8dH.

In areas where the water is soft it is not necessary to use a water softener.

































To find out the water hardness in your area, contact your local water authority.

Use the correct quantity of water softener.

Follow the instructions that you find on the packaging of the product./or www.electrolux.com

16. INTERNATIONAL WASH CODE SYMBOLS

i These symbols appear on fabric labels, in order to help you choose the best way to treat your laundry.

 Energetic wash	 Max. wash temperature 95 °C	 Max. wash temperature 60 °C	 Max. wash temperature 40 °C	 Max. wash temperature 30 °C	 Hand wash	 DO NOT wash at all
 Delicate wash		 Max. wash temperature 60 °C	  Max. wash temperature 40 °C	 Max. wash temperature 30 °C		
 Bleaching	 Bleach with Chlorine			 DO NOT bleach		
 Ironing	 Hot iron max. 200 °C	 Warm iron max. 150 °C	 Lukewarm iron max. 110 °C	 DO NOT iron		
 Dry cleaning	 Dry cleaning in all solvents	 Dry cleaning in perchloroethylene, petrol, pure alcohol, R 111 & R 113		 Dry cleaning in petrol, pure alcohol and R 113	 DO NOT dry clean	
 Drying	 Flat	 On the line	 On clothes hanger	 Medium temperature  Low temperature Tumble dry	 DO NOT tumble dry	

17. CARE AND CLEANING

⚠ WARNING!

You must **DISCONNECT** the appliance from the electricity supply, before you can carry out any cleaning or maintenance work.

17.1 External Cleaning

Clean the appliance only with soap and warm water. Fully dry all the surfaces.

Do not use a scouring pads or any scratching material.

⚠ CAUTION!

Do not use alcohol, solvents or chemical products.
Do not clean the metal surfaces with chlorine-based detergent.

17.2 Descaling

The water we use normally contains lime. It is a good idea to periodically use a water softening powder in the machine.

Do this separately from any laundry washing, and according to the softening powder manufacturer's instructions.

This will help to prevent the formation of lime deposits.

17.3 After Each Wash

Leave the door open for a while. This helps to prevent mould and stagnant smells forming inside the appliance.

Keeping the door open after a wash will also help to preserve the door seal.

17.4 Maintenance Wash

The repeated and prolonged use of low temperature and short programmes can cause detergent deposits, fluff residues, bacterial growth and biofilm formation inside the drum and the tub.

This could generate bad odours and mildew.

To eliminate these deposits and hygienize the inner part of the appliance, run a maintenance wash at least once a month:

1. Remove all laundry from the drum.
2. Deactivate AutoDose function for detergent and softener.
3. Run a cottons programme with the highest temperature with a small quantity of powder detergent or, if available, run the Tub Clean programme.

17.5 Door Seal

This appliance is designed with a **self cleaning draining system**, allowing light fluff fibres that fall off the clothes to be drained out with the water. Regularly examine the seal. Coins, buttons, other small items can be recovered at the end of the cycle.

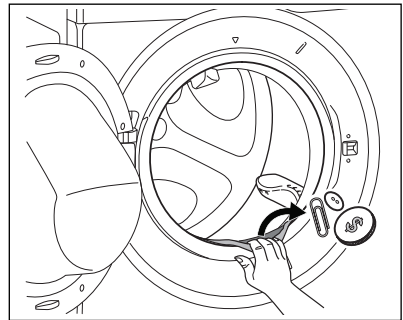

Clean it when needed, using ammonia cream cleanser agent without scratching the seal surface.

i Always obey the instructions that you find on the packaging of the product.

17.6 Cleaning The Detergent Dispenser and The Autodose Tanks

⚠ CAUTION!

If you change detergent type as brand, concentration, and thickness, then it is suggested to clean the detergent drawer.

i Before cleaning, make sure that the all compartments are empty.

To prevent possible deposits of dried detergent, clotted fabric softener, formation of mould in the detergent dispenser, and/or clotted liquid additives in the AutoDose tanks, **once in a while carry out the following cleaning procedure:**

1. Open the detergent dispenser. Press the catch as indicated in the picture and pull the detergent dispenser out.

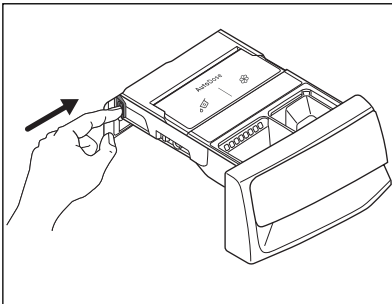

2. Remove the insert for the softener and, if inserted.

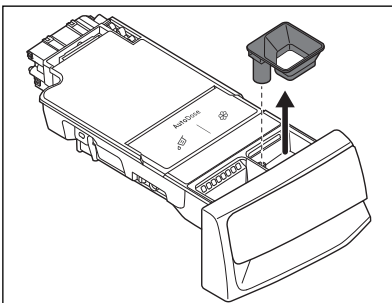

3. Press the catch on the back as indicated in the picture and lift up the top cover to open.

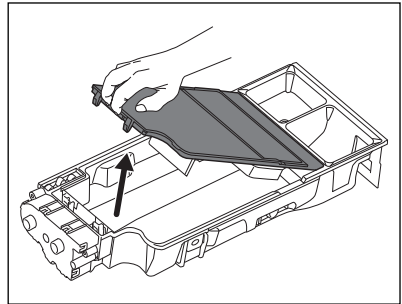
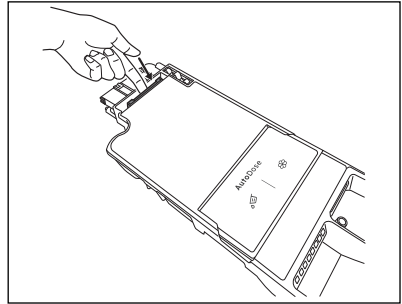

4. Wash the drawer and all inserts under running water.

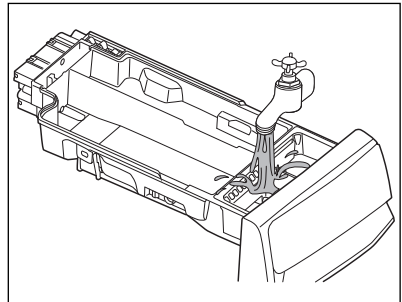

⚠ CAUTION!

Do not use sharp or metal brushes and sponges. Do not wash drawer in the dish washer.

5. Turn the dispenser up side down and open the bottom cover as indicated in the picture.

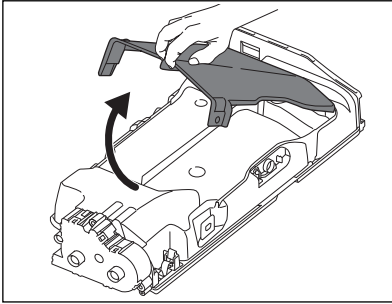

6. Make sure that all detergent residue is removed from the conveyor. Use only soft damp clothes.
7. Put bottom cover back to its position by aligning its holes on drawer hooks as indicated in the picture. Close it till "click" sound.

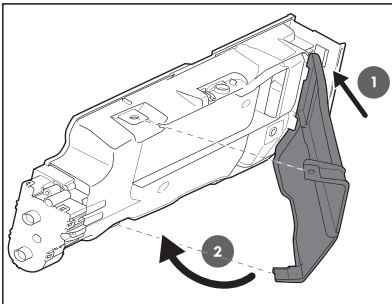

⚠ CAUTION!

Press the bottom cover as indicated in the picture. Make sure that it is closed properly.

⚠ WARNING!

Do not clean with any sharp and metal brushes or any tools to avoid damaging pumps and sensors allocated on the back of the detergent drawer. If necessary, use only soft damp clothes.

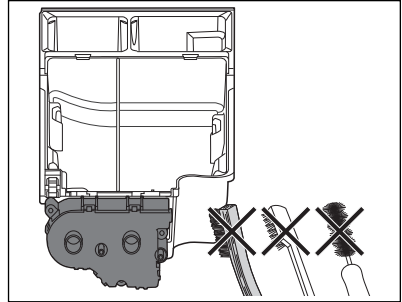
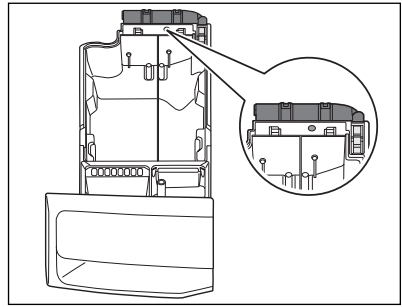

⚠ WARNING!

If some residues remain on the back area of tanks, soak detergent drawer in a warm water. Do not use tools to clean it. Before soaking, remove the handle by pressing the button and slide the handle as indicated in the picture.

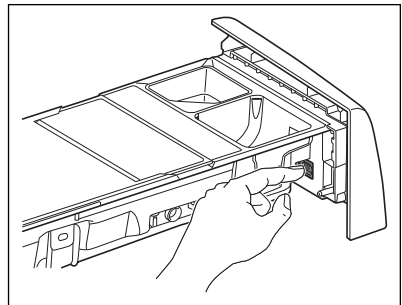

8. Make sure that all detergent residue is removed from the upper and lower part of the recess. Use a small brush to clean the recess.

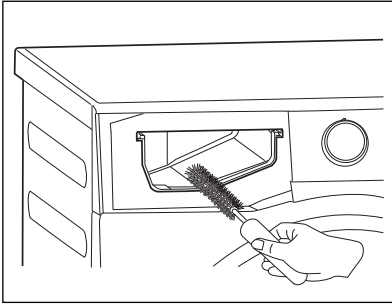

9. Reassembly the drawer as follows:

- a. Place the handle if was disassembled.
- b. Place the bottom cover and press till "click" sound.
- c. Place the top cover on the tanks compartment and press till "click" sound.
- d. Replace components on manual compartment.

10. Insert the detergent dispenser into the guide rails and gently close it till "click" sound. Run the Quick 15 programme without any clothes in the drum.

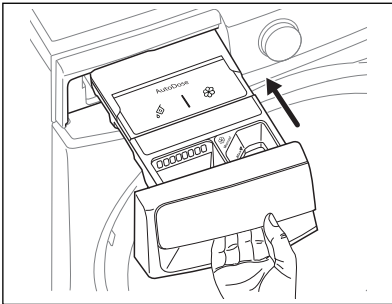

 To restore the functionality, refill tanks with detergent and softener.

17.7 Cleaning The Drain Pump

 Disconnect the mains plug from the mains socket.

 Regularly examine the drain pump and make sure that it is clean.

Clean the drain pump if:

- The appliance does not drain the water.
- The drum cannot turn.
- The appliance makes an unusual noise because of the blockage of the drain pump.
- The message Check that the drain filter is not clogged pops up.

WARNING!

- Do not remove the filter while the appliance operates.
- Do not clean the pump if the water in the appliance is hot. Wait until the water cools down

Proceed as follows to clean the pump:

1. Open the drain pump door.

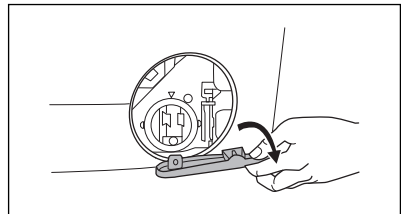
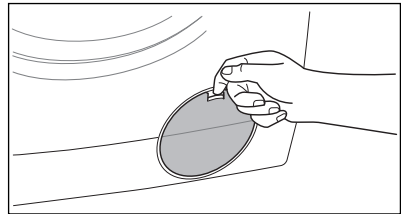

2. Place a suitable water container below the recess of the drain pump to collect the water that flows out. Press the two levers and pull forward the drainage duct to let the water flow out.

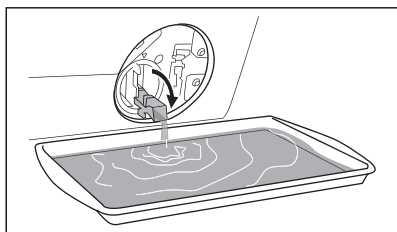
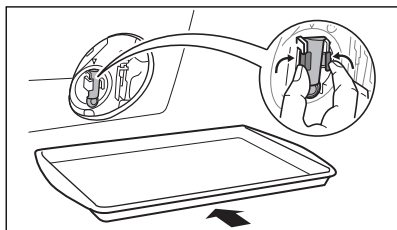

3. When the container is full of water, put the drainage duct back again and empty the container. Repeat the step 2, 3 until no more water flows out.
4. Push back the drainage duct.

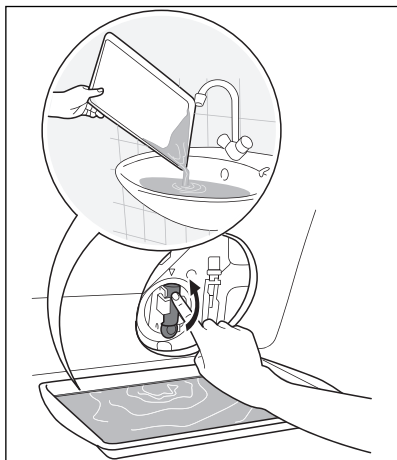

Turn the filter counter-clockwise to remove it.

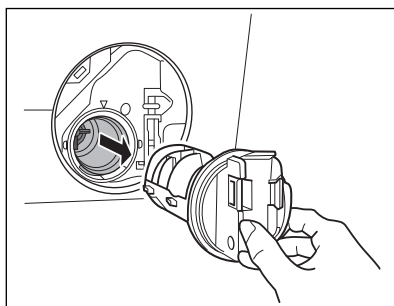
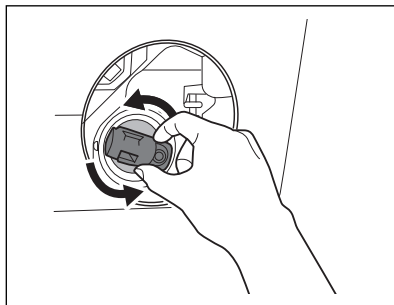

5. Remove fluff and objects from the pump (if there are any).

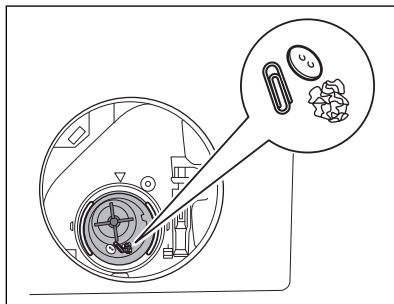

6. Make sure that the impeller of the pump can turn. If this does not occur, contact the service centre.

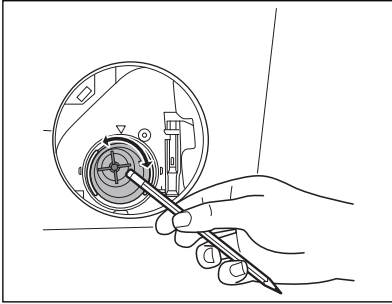

7. Clean the filter under the water tap.

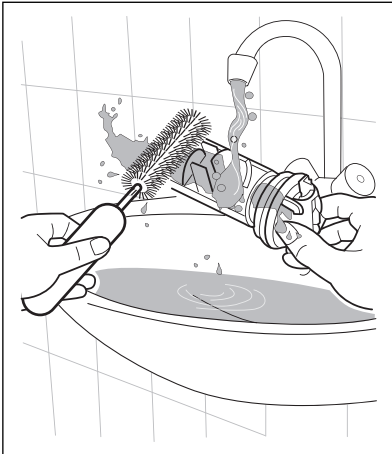

8. Put the filter back into the housing with exposed section facing up. Make sure that you correctly tighten the filter to prevent leakages.

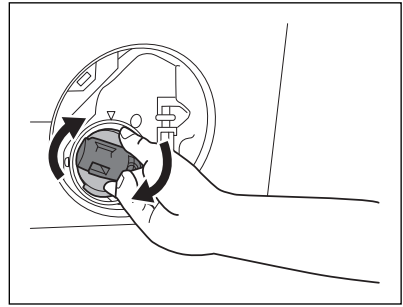
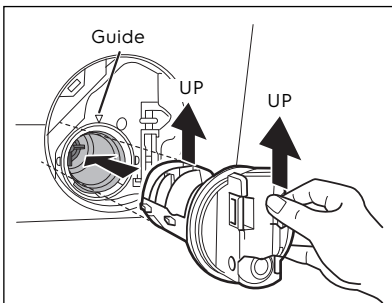

9. Close the drain pump door.

17.8 Cleaning The Water Inlet Filter

If your water is very hard or contains traces of lime deposit, the water inlet filter may become clogged. It is therefore a good idea to clean it from time to time.

To clean the water inlet filters:

1. Close the water tap.
2. Remove the water inlet hose from the water tap.
3. Clean the filter in the inlet hose with a stiff brush.

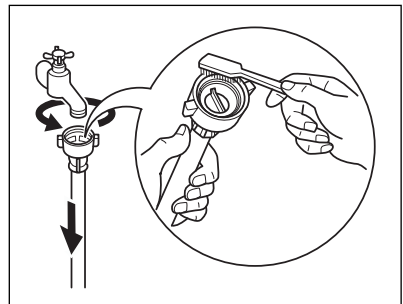

4. Remove the inlet hose behind the appliance.

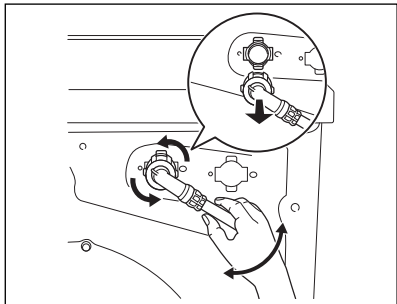

5. Use a suitable tool pulling filter from the valve (e.g. long nose pliers) as picture.

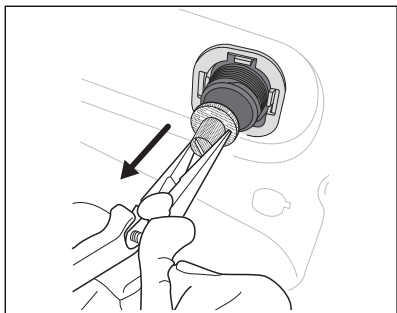
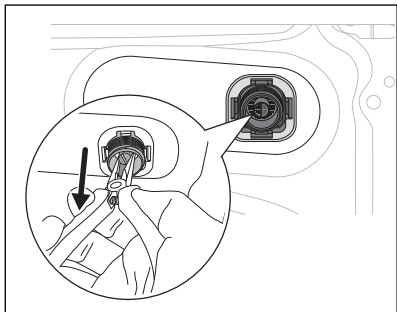

Clean the filter under the water tap.

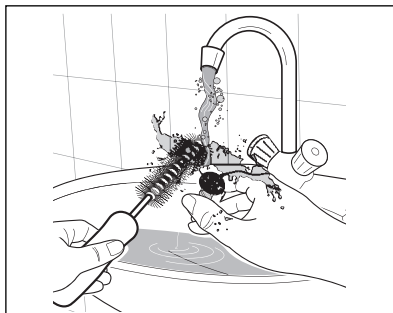

Install the valve filter back to the housing.

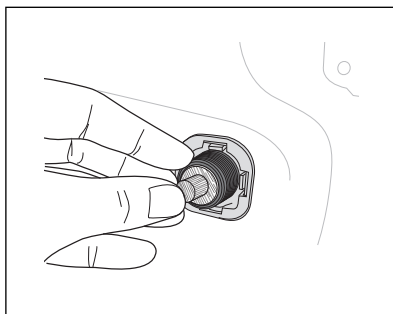

6. Install the inlet hose again. Make sure that the couplings are tight to prevent leakages.
7. Open the water tap.

17.9 Emergency Drain

If the appliance cannot drain the water, carry out the same procedure, described in 'Cleaning the drain pump' paragraph. If necessary, clean the pump.

When you drain the water with the emergency drain procedure, you must activate the drain system again:

1. Put 2 litres of water in the main wash compartment of the detergent dispenser.
2. Start the programme to drain the water.

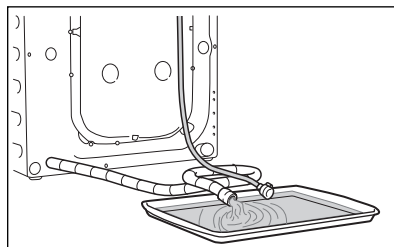

6. When no more water flows, install the inlet hose again.

17.10 Frost Precautions

If the appliance is installed in an area where the temperature can be less than 0 °C, remove the remaining water from the inlet hose and the drain pump.

1. Disconnect the main plug from the main socket.
2. Close the water tap.
3. Remove the water inlet hose.
4. Remove the drain hose from the rear support and unhook it from sink or spigot.

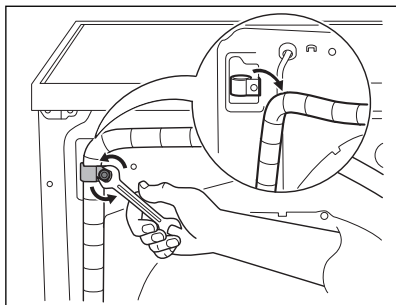

5. Put the end of the drain and inlet hose in a container. Let the water flow out of the hoses.

i Make sure that the temperature is more than 0 °C before you use the appliance again.
The manufacturer is not responsible for damages caused by low temperatures.

18. TROUBLESHOOTING

18.1 Possible Failures

Certain problems are due to lack of simple maintenance or oversights, which can be solved easily without calling out an engineer. Before contacting your local Service Centre, please check troubleshooting below.

Once the problem has been eliminated, press the Start/Pause button to restart the programme. If after all checks, the problem persists, contact your local Service Centre.

WARNING!

Deactivate the appliance before you do the checks.

If an error appears on the display, please follow the initial troubleshooting steps as suggested.

Malfunction	Possible cause	Solution
Machine does not start:	The door has not been closed.	Close the door firmly.
	The plug is not properly inserted into the power socket.	Insert the plug into the power socket.
	There is no power at the socket.	Please check your domestic electrical installation.
	The Start/Pause touch key has not been pressed.	Press the Start/Pause touch key.
	The "Finish In" has been selected.	If the laundry are to be washed immediately, cancel the "Finish In".
	The Main supply is unstable.	Wait until the main supply is stable. Appliance will start automatically.
Machine does not fill the water:	The water tap is closed.	Open the water tap.
	The inlet hose is squashed or kinked.	Check the inlet hose connection.
	The filter in the inlet hose is blocked.	Clean the water inlet hose filter.
	The door is not properly closed.	Close the door firmly.
Machine fills then empties immediately:	The end of the drain hose is too low.	Refer to relevant paragraph in "water drainage" section.

Malfunction	Possible cause	Solution
Machine does not empty and/or does not spin:	The drain hose is squashed or kinked.	Check the drain hose connection.
	The drain pump is clogged.	Clean the drain filter.
	The option "Rinse Hold" has been selected.	Press Start/Pause touch key to drain the water or select spin programme.
	The laundry is not evenly distributed in the drum.	Pause the machine and redistribute laundry manually.
There is water on the floor:	Too much detergent or unsuitable detergent (creates too much foam).	Reduce detergent quantity and use correct type of detergent (see page 44).
	Water leaks inside the machine.	Disconnect the main plug from the main socket. Close the water tab. Call Service.
	Water leaks from inlet hose fittings.	Check the water inlet hose connection.
	The drain hose is damaged.	Call Service.
Unsatisfactory washing results:	Too little detergent or unsuitable detergent has been used.	Increase detergent quantity or use different detergent (see page 44).
	Stubborn stains have not been treated prior to washing.	Use commercial products to treat the stubborn stains.
	The correct temperature was not selected.	Check if you have selected the correct temperature.
	Excessive laundry load.	Reduce load.
The door will not open:	The programme is still running.	Wait until the end of cycle.
	There is water in the drum.	You must drain the water to open the door.
	This problem may be caused by a failure of the appliance.	Contact Service. If you need to open the door, please read carefully "Emergency door opening" on page 58.
Machine vibrates or is noisy:	The transit bolts and packing have not been removed.	Check the correct installation of the appliance.
	The support feet have not been adjusted.	Check the correct levelling of the appliance.
	The laundry is not evenly distributed in the drum.	Pause the machine and redistribute laundry manually.

Malfunction	Possible cause	Solution
Machine vibrates or is noisy:	There is very little laundry in the drum.	Load more laundry.
	Unstable floors e.g. wooden floors.	Refer to relevant paragraph in "Positioning" section.
Cycle time longer than displayed:	Detergent over dose.	Reduce the detergent quantity or use another one. (see page 44)
	Machine unbalance.	Redistribute laundry manually in the drum and start the spin phase again.
The cycle is shorter than the time displayed.	The appliance calculated a new time according to the laundry load.	
Spinning starts late or machine does not spin:	The electronic unbalance detection device has cut in because the laundry is not evenly distributed in the drum. The laundry is redistributed by reverse rotation of the drum.	Pause the machine and redistribute laundry manually.
	This may happen several times before the unbalance disappears and normal spinning can resume. If, after 10 minutes, the laundry is still not evenly distributed in the drum, the machine will not spin. In this case, redistribute the load manually and select the spin programme.	
Machine makes an unusual noise:	Machine not installed properly.	Make sure the levelling of the appliance is correct. Refer to section "Installation".
	Transit bolts or packaging not removed.	Make sure that the packaging and/or the transit bolts are removed. Refer to section "Unpacking".
	The load may be too small.	Add more laundry in the drum.
No water is visible in the drum:	Machines based on modern technology operate very economically using very little water without affecting performance.	
Remote function does not work:	Registration data lost or damaged.	Restart machine by turn Off and turn On again. If problem not solved, please contact Service Centre.
Machine does not start *AutoDose models	Sensing circuit of Autodosing faulty.	Switch off and switch on again. If still have the problem, please call Service Centre.

i If you are unable to identify or solve the problem, contact our service centre. Before calling, make a note of the model, serial number in the rating label behind the door when you open, and purchase date of your machine.

18.2 Emergency Door Opening

In case of power failure or appliance failure, the appliance door remains locked. The wash programme continues when power is restored. If the door remains locked in case of failure, it is possible to open it using the emergency unlock feature.

Before opening the door:

⚠ WARNING!

Make sure that the water temperature and the laundry are not too high. Wait until they cool down if necessary. Make sure that the water level inside the drum is not too high. If necessary, perform an **Emergency Drain** chapter. Make sure that the drum is not rotating. Wait until the drum stops rotating if necessary.

To open the door proceed as follows:

1. Press the On/Off **i** button to switch the appliance off.
2. Disconnect the mains plug from the mains socket.
3. Open the filter cover.
4. Using a suitable tool to pulling the emergency unlock strap (red strap) downward twice (you will hear "click" sound) and hold it, at the same time pull the door handle to open the door.

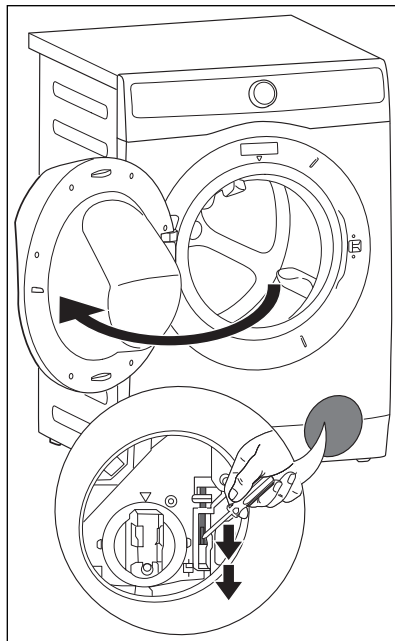

If the door cannot open while holding the strap, try to release it then open the door.

5. Take out the laundry.
6. Close the filter door.



19. ENVIRONMENT CONCERNS

19.1 Packaging Materials

 The materials marked with the symbol  are recyclable.

>PE<=polyethylene

>PS<=polystyrene

>PP<=polypropylene.

This means that they can be recycled by disposing them properly in appropriate collection containers.

19.2 Old Machine

Use authorized disposal sites for your old appliance. Help to keep your country tidy!

The symbol  on the product or on its packaging indicates that this product may not be treated as household waste.

Instead it shall be handed over to the applicable collection point for the recycling of electrical and electronic equipment. By ensuring this product is disposed of correctly, you will help prevent potential negative consequences for the environment and human health, which could otherwise be caused by inappropriate waste handling of this product.

For more detailed information about recycling of this product, please contact your local city office, your household waste disposal service or the shop where you purchased the product.

19.3 Ecological Hints

To save water, energy and to help protect the environment, we recommend that you follow these tips:

- Normally soiled laundry may be washed without pre-washing in order to save detergent, water and time (the environment is protected too!).
- The machine works more economically if it is fully loaded.
- With adequate pre-treatment, stains and limited soiling can be removed; the laundry can then be washed at a lower temperature.
- Measure out detergent according to the water hardness, the degree of soiling and the quantity of laundry being washed.

electrolux.com

G0044168-001-A28643701